

Every effort has been made to ensure that the information in this document is complete, accurate and up-to-date. Phonetics, Inc. assumes no responsibility for the results of errors beyond its control. Phonetics, Inc. also cannot guarantee that changes in equipment made by other manufacturers, and referred to in this manual, will not affect the applicability of the information in this manual.

Copyright 1997 by Phonetics, Inc.

Second Edition, version 2.02, September 2000.

Written and produced by Phonetics, Inc.

Phonetics, Inc.

Sensaphone is a registered trademark of Phonetics, Inc.

Touch Tone is a registered trademark of AT&T.

Contents

IMPORTANT SAFETY INSTRUCTIONS	i
CAUTION	ii
CHAPTER 1: INTRODUCTION.....	1
PROGRAMMING Express II	1
ABOUT THIS MANUAL	1
CHAPTER 2: INSTALLATION.....	3
OPERATING ENVIRONMENT	3
MOUNTING Express II	3
STRAIN RELIEF	4
POWERING UP	4
GROUNDING AND POWER SURGE PROTECTION	4
BACKUP BATTERY	4
TURNING EXPRESS II ON	5
POWER SUPPLIES	6
RS232 PRINTER PORT	6
FCC REQUIREMENTS	7
NOTICE	7
CHAPTER 3: INPUTS.....	9
HOW THE INPUTS WORK	9
LEDs	10
CONFIGURING THE INPUTS	10
WIRING THE INPUTS	11
STRAIN RELIEF	14
SHIELDED WIRE	14
WIRE LENGTH	14
INSTALLING INPUT EXPANSION CARDS	15
INPUT SPECIFICATIONS	16
2.8K THERMISTOR LOOK-UP TABLE	17
10K THERMISTOR LOOK-UP TABLE	18
CHAPTER 4: OUTPUTS.....	19
HOW THE OUTPUTS WORK	19
WIRING THE OUTPUTS	19
STRAIN RELIEF	20
INSTALLING OUTPUT EXPANSION CARDS	20
RELAY OUTPUT SPECIFICATIONS	21
CHAPTER 5: PROGRAMMING	23
MOVING THROUGH THE MENUS	23
PROGRAMMING PHONE PARAMETERS.....	24
Calling Schedule	24
Phone Contacts	26
Communications Type	26
Special Dialing Codes	26
Phone Contacts:	26
DIAL OUT	28
Dialing Method	28

Retries on Busy	28
Message Repeat	28
Maximum Number of Calls	29
Call Delay Time	29
Intercall Delay Time	29
DIAL IN	30
Rings Until Answer	30
TAD enable/disable	30
Calling Express II with TAD Enabled	31
MESSAGES	32
INPUTS	33
Enable/Disable Inputs	33
Input Type	33
Recognition Time	34
High/Low Limits	34
Alarm Reset Time	35
Dial Out Selection	35
Calibration	35
Reset Value	35
SOUND	36
Listen-in Time	36
Sound Monitoring	36
Sound Sensitivity	36
Recognition Time	36
Alarm Reset Time	37
Dialout Selection	37
Mute Local Speaker	37
POWER	38
POWER PARAMETERS	38
AC POWER	38
Failure monitoring	38
Power Recognition time	38
Alarm reset time	38
Dialout Selection	38
BATTERY	39
Battery monitor	39
Alarm reset time	39
Dialout selection	39
OUTPUTS	41
DATA LOG	42
Input/Output Log	42
Activity Log	42
SYSTEM	43
Password	43
Date and time	43
Acknowledgment code	43



Important Safety Instructions

Your Sensaphone Express II has been carefully designed to give you years of safe, reliable performance. As with all electrical equipment, however, there are a few basic precautions you should take to avoid hurting yourself or damaging the unit:

- Read the installation and operating instructions in this manual carefully. Be sure to save it for future reference.
- Read and follow all warning and instruction labels on the product itself.
- To protect the Sensaphone Express II from overheating, make sure all openings on the unit are not blocked. Do not place on or near a heat source, such as a radiator or heat register.
- Do not use your Sensaphone Express II near water, or spill liquid of any kind into it.
- Be certain that your power source matches the rating listed on the AC power transformer. If you're not sure of the type of power supply to your facility, consult your dealer or local power company.
- Do not allow anything to rest on the power cord. Do not locate this product where the cord will be abused by persons walking on it.
- Do not overload wall outlets and extension cords, as this can result in the risk of fire or electric shock.
- Never push objects of any kind into this product through ventilation holes as they may touch dangerous voltage points or short out parts that could result in a risk of fire or electric shock.
- To reduce the risk of electric shock, do not disassemble this product, but return it to Phonetics' Customer Service, or another approved repair facility, when any service or repair work is required. Opening or removing covers may expose you to dangerous voltages or other risks. Incorrect reassembly can cause electric shock when the unit is subsequently used.
- If anything happens that indicates that your Sensaphone Express II is not working properly or has been damaged, unplug it immediately and follow the procedures in the manual for having it serviced. Return the unit for servicing under the following conditions:
 1. The power cord or plug is frayed or damaged.
 2. Liquid has been spilled into the product or it has been exposed to water.
 3. The unit has been dropped, or the enclosure is damaged.
 4. The unit doesn't function normally when you're following the operating instructions.



- Avoid using a telephone (other than a cordless type) during an electrical storm. There may be a remote risk of electric shock from lightning.
- Do not use the telephone to report a gas leak in the vicinity of the leak.

CAUTION

To reduce the risk of fire or injury to persons, read and follow these instructions:

1. Use only the following type and size battery: Sealed lead-acid 12v 3.0 AH.
2. Do not dispose of the battery in a fire. The cell may explode. Check with local codes for possible special disposal instructions.
3. Do not open or mutilate the batteries. Released electrolyte is corrosive and may cause damage to the eyes or skin. It may be toxic if swallowed.
4. Exercise care in handling battery in order not to short the battery with conducting materials such as rings, bracelets, and keys. The battery or conductor may overheat and cause burns.

CHAPTER 1: INTRODUCTION

Welcome to the Sensaphone Express II by Phonetics, Inc. Express II is a powerful environmental and process monitoring system. It handles your current monitoring, alarm and control needs, and is able to grow when your application grows.

Express II comes standard with 8 universal input channels and one built-in relay output. Input capacity is expandable up to 40 channels (on 5 cards). Output capacity may be expanded up to 16 channels (on two cards), in which case input is limited to 24 channels (3 cards).

Express II can call up to 48 Phone Contacts, using pulse or Touch-Tone dialing. Dialing Schedules and Phone Contact List features enable you to create a priority dialing list depending on which input is alarm-activated, the time of day, and day of week. Call progress detection ensures that no time is wasted on busy signals and no-answers during the dialout sequence.

PROGRAMMING Express II

Express II's unique programming style allows you to access all programmable parameters quickly and easily. The parameters are organized into 10 categories. From there, programming is completely voice guided in a menu-style format. You simply enter the category number for the parameters you want to program and enter values as prompted. All programming can be accomplished using the local keypad on the unit, or remotely using a Touch-Tone™ phone.

The Express II has a one-year limited warranty. Within the packaging will be a Warranty Registration card. Please take the time to fill this out and mail. The warranty is explained in the back of this manual.

ABOUT THIS MANUAL

This manual comprises the instructions and commands necessary to install and program Express II. In addition, summary and application chapters are included to help you speed programming and to understand Express II's features.



NOTES

CHAPTER 2: INSTALLATION

This chapter provides the information necessary to install the Sensaphone Express II. Correctly installing the unit will ensure proper functioning and maximum service life. Please read the entire chapter before attempting installation.

Within the packaging is a Warranty Registration card. Please take the time to fill this out and mail it. The Limited 1 Year Warranty is explained on the last page of this manual.

OPERATING ENVIRONMENT

Express II should be mounted and operated in a safe environment. Do not mount the unit where it will be subject to shock and vibration. The temperature range the Express II can operate in is 32°F to 130°F (0°C to 55°C). If you require Express II to operate in a below freezing environment, you must take safe and practical measures to keep the unit's temperature above 32°F or it will not operate reliably.

CAUTION: Express II is a sensitive electronic device. Personnel and work area should be grounded before handling this device. Do not install Express II near strong electrostatic, electromagnetic, magnetic or radioactive fields. Do not expose it to fumes or corrosive vapors.

MOUNTING Express II

When you receive Express II, carefully remove it from the box. On the top and bottom of the enclosure are mounting holes to attach the unit to either a panel or wall. The mounting surface should be sturdy enough to support 15 lbs. The unit should be mounted using four #12-24 bolts where appropriate, or four #12 tapping screws. When mounting the unit to a wall make sure the mounting screws fully engage a solid member, (e.g. a stud), of the support structure. Mount Express II in an upright position so that you can easily gain access to the front panel. There must be a power outlet and telephone jack nearby. The dimensions of the full enclosure are: 14.50"H x 13.06"W x 8.31"D. See Figure 1 below:

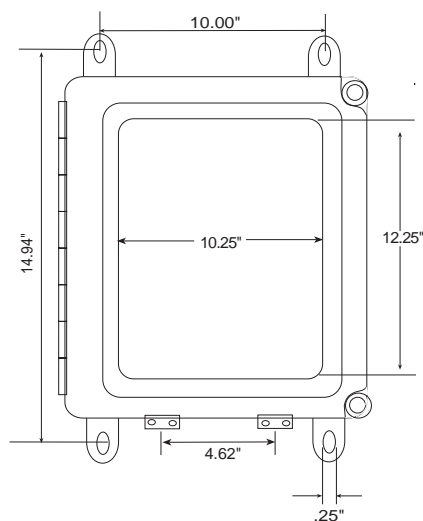

Figure 1: Mounting dimensions

STRAIN RELIEF

Strain relief clamps are provided on the Express II enclosure to prevent wiring from being pulled from the circuit board or damaged when passing through the enclosure. To use the strain relief, thread wires through the clamp and the clear rubber bushing. Position the bushing in the clamp and tighten the screws on either side so that the wiring does not move. See Figure 2 below:

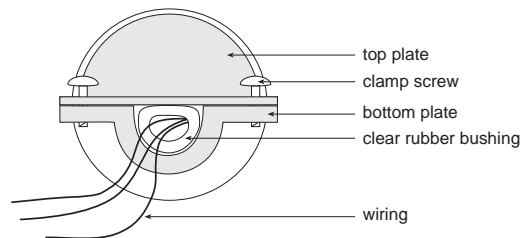

Figure 2: Strain relief clamp

POWERING UP

Express II is provided with a 12V AC power transformer. This should be plugged into a 117V AC outlet, $\pm 20\%$, 60HZ.

The transformer is pre-wired to the terminals labelled AC.

GROUNDING AND POWER SURGE PROTECTION

Express II should be earth grounded by connecting a true earth ground to the terminal labeled EG. This is not essential for Express II to operate, but it is necessary to prevent possible damage by a lightning strike.

The Sensaphone® Express II can be damaged by power surges and lightning through the telephone line and the power supply. Although Express II has built-in surge protection, **we strongly recommend** that additional protection be obtained for the unit and for any electronic equipment that is attached to your power supply and telephone lines. Power surge protection is especially important if you live in a lightning-prone area. Surge protection is available through Phonetics. Call for details.

BACKUP BATTERY

Express II has a 12V 3AH sealed lead-acid Gel-Cell rechargeable battery. This will provide approximately 6-12 hours backup time. Actual backup time will depend upon the number of input/output cards installed in the unit, the number of sensors being powered from the unit, temperature, battery age, and dialing activity. The battery comes pre-wired with the red wire attached to the BAT IN(+) terminal and the black wire attached to the BAT IN(-) terminal.

Express II will automatically charge the battery whenever the power switch is turned on and the power transformer is plugged in. The unit also includes special circuitry to prevent the battery

from being damaged in the event of an extended power outage. When the battery runs down to 9V, the unit will automatically disconnect it, preventing deep-discharge damage. The battery will remain disconnected until it charges back up to 12.3 volts. The battery should provide 5 years of service before needing replacement.

NOTE: Have battery serviced by qualified service personnel only.

The main motherboard and plug-in cards also include a 3V lithium battery to retain user-recorded messages and programming when the unit is turned off. Each battery will provide two years of backup time while the unit is turned off and up to 10 years of intermittent use.

NOTE: Have the lithium battery serviced by qualified service personnel only.

TURNING Express II ON

Now that Express II has power, the ON-OFF switch may be turned on.

When the unit is turned ON, it will perform a series of diagnostic tests of its internal circuitry. When all of the tests have been completed, the unit will say, "Express II, OK." The unit is now operating and will respond to keypad commands and answer telephone calls.

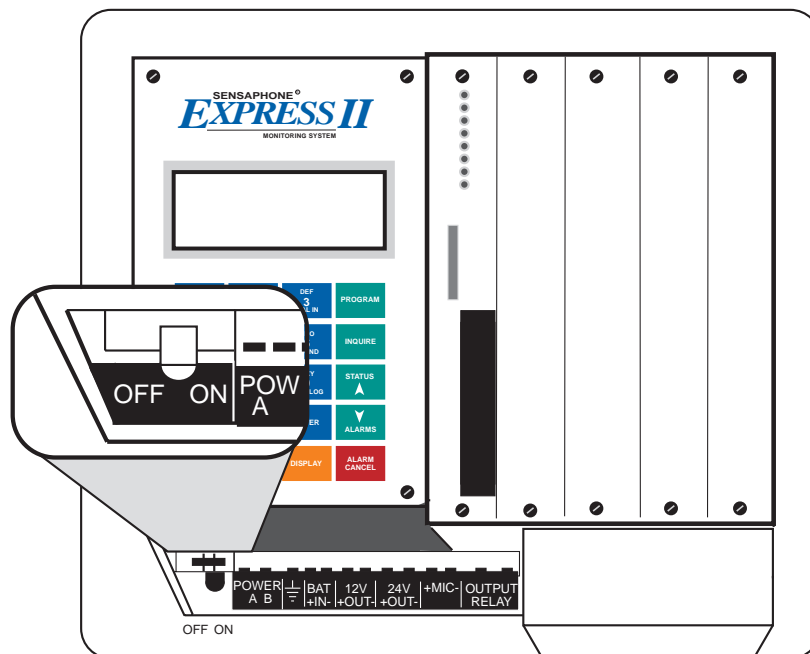

Figure 3: On/Off Switch Location



FCC REQUIREMENTS

PART 68 - This equipment complies with Part 68 of the FCC rules. On the side of the enclosure there is a label that contains, among other information, the FCC Registration Number and the Ringer Equivalence Number (REN) for this equipment. You must, upon request, provide this information to your local telephone company.

The REN is useful to determine the quantity of devices that you may connect to your telephone line and still have all of those devices ring when your telephone number is called. In most, but not all areas, the sum of the REN's of all devices connected to one line should not exceed five (5.0). To be certain of the number of devices that you may connect to your line, you may want to contact your local telephone company to determine the maximum REN for your calling area.

This equipment may not be used on coin service provided by the telephone company. Connection to party lines is subject to state tariffs.

Should Express II cause harm to the telephone network, the telephone company may discontinue your service temporarily. If possible, they will notify you in advance. But if advanced notice isn't practical, the telephone company may temporarily discontinue service without notice and you will be notified as soon as possible. You will be informed of your right to file a complaint with the FCC. The telephone company may make changes in its facilities, equipment, operations, or procedures where such action is reasonably required in the operation of its business and is not inconsistent with the rules and regulations of the FCC that could affect the proper functioning of your equipment. If they do, you will be notified in advance to give you an opportunity to maintain uninterrupted telephone service.

. The telephone company may ask that you disconnect this equipment from the network until the problem has been corrected or until you are sure that the equipment is not malfunctioning.

PART 15 - This equipment has been tested and found to comply with the limits for a Class A digital device, pursuant to Part 15 of the FCC Rules. These limits are designed to provide reasonable protection against harmful interference when the equipment is operated in a commercial environment. This equipment generates, uses and can radiate radio frequency energy and if not installed and used in accordance with the instruction manual, may cause harmful interference to radio communications. Operation of this equipment in a residential area is likely to cause harmful interference in which case the user will be required to correct the interference at his own expense.

Safety Approvals

The Sensaphone Express II Remote Monitoring System (Model 6700) is NRTL listed in compliance with UL Standard 1950 "Information Technology Equipment" and CSA Standard 22.2 #950. The unit is certified by MET Laboratories, a Nationally Recognized Testing Laboratory (NRTL), and is listed under file number E1 12098.

NOTICE

The Canadian Department of Communications label identifies certified equipment. This certification means that the equipment meets certain telecommunications network protective operational and safety requirements. The Department does not guarantee the equipment will operate to the user's satisfaction.

Before installing this equipment, users should ensure that it is permissible to be connected to the facilities of the local telecommunications company. The equipment must also be installed using an acceptable method of connection. In some cases, the company's inside wiring associated with a single line individual service may be extended by means of a certified connector assembly (telephone extension cord). The customer should be aware that compliance with the above conditions may not prevent degradation of service in some situations.

Repairs to certified equipment should be made by an authorized Canadian maintenance facility designated by the supplier. Any repairs or alterations made by the user to this equipment, or equipment malfunctions, may give the telecommunications company cause to request the user to disconnect the equipment.

Users should ensure for their own protection that the electrical ground connections of the power utility, telephone lines and internal metallic water pipe system, if present, are connected together. This precaution may be particularly important in rural areas.

CAUTION: Users should not attempt to make such connections themselves, but should contact the appropriate electric inspection authority, or electrician, as appropriate.

The Load Number (LN) assigned to each terminal device denotes the percentage of the total load to be connected to a telephone loop which is used by the device to prevent overloading. The termination on a loop may consist of any combination of devices subject only to the requirement that the total of the Load Numbers of all the devices does not exceed 100. For the Sensaphone Express II the Load Number is 7.

CHAPTER 3: INPUTS

Express II comes standard with 8 universal inputs. The input capacity may be expanded in additional sets of 8 inputs. There are 5 slots, offering a total of 40 possible universal input channels. All the inputs--the 8 standard and the expanded sets--can be configured to accept the following type sensors:

- Normally closed dry contact (digital)
- Normally open dry contact (digital)
- Pulse count
- 4-20 mA (analog)
- 0-5 Volts (analog)
- Temperature
 - 2.8K F thermistor (analog)
 - 2.8K C thermistor (analog)
 - 10K F thermistor (analog)
 - 10K C thermistor (analog)
- Time accumulator

The standard 8 input terminal block is located to the right of the built-in keypad in the first card slot. Above the terminal block are a row of 8 LEDs that indicate the status of the inputs to on-site personnel.

HOW THE INPUTS WORK

Express II reads the value of each input by measuring the voltage across the input and the common terminals. When the shunts are positioned for a specific type of sensor, Express II uses a different circuit to measure the appropriate reading for that sensor. The common Express II sensor types follow:

Dry Contact - These digital sensors can be either Normally Open or Normally Closed (designated N.O/N.C). If a normally open sensor becomes closed, a contact occurs. This causes an alarm. Conversely, if a normally closed sensor becomes open, the contact disappears, and this condition causes an alarm. Typical dry contact sensors include magnetic reed switches and water detection sensors. An example would be a security system where a N.C. magnetic switch opens as a window is raised.

Pulse Count - This configuration will allow the input channel to count pulses. A typical pulse count sensor is a flow meter that uses a turbine to measure flow by accumulating pulses. Max pulse rate for this configuration is 1Hz. Compatible with mechanical relays, open drain and open collector transistor devices.

4-20 mA - This sensor configuration connects the input signal to a 237 Ohm load resistor. This allows Express II to measure the current at the input. Any powered or unpowered sensor that puts out 4-20mA can be wired. Any input range can be specified by the user. Typical sensors include pressure gauges, analog flow meters, and temperature gauges. Input resolution is 12 bits.

.....

0-5 Volts - This configuration connects the input signal directly to Express II's analog to digital converter for measuring the output of 0 to 5V transducers. Any sensor that puts out 0-5V can be wired. Any input range can be specified by the user. Typical sensors include pressure gauges, voltage meters, and flow meters. Express II can read the voltage between 0 Volts and 5 Volts in increments of .00122 Volts. Input resolution is 12 bits.

Thermistor - Two kinds of thermistors may be used with Express II: a 2.8K thermistor or a 10K thermistor. The range for an input measuring temperature for 2.8k is -65.0° to 93.33° C (-85° F to 200° F), and for 10k is -62.22° C to 148.89° C (-80° F to 300° F) . This configuration type connects the input signal to a 5V reference through a 6.34K pull-up resistor.

Time accumulator - The time accumulator works only with N.O. Dry Contacts. As the name suggests, it will accumulate and tally the total amount of time--in hours, minutes, and seconds--that the input sensor is in the closed position. This would be useful, for instance, in maintaining total run time for a given device.

LEDs

Each input has a corresponding LED that indicates input status. The LEDs are located above the terminal block. When an LED is *steady green*, that indicates that the input is OK and no alarms exist. When an LED is *blinking green*, the input is in alarm condition, but the preset recognition time has not been met to qualify as an unacknowledged alarm. When an LED is *blinking red*, that indicates that an unacknowledged alarm exists on the corresponding input. When an LED is *steady red*, it indicates that an alarm has been acknowledged but still exists on the corresponding input. If the input is disabled, the LED goes off for that input. NOTE: If the LED changes from blinking green directly to steady red, the input is not set up properly to dial out with an alarm.

CONFIGURING THE INPUTS

Each of the inputs must be configured so that Express II will know what type of signal it must read. To configure the inputs, you must position the shunts that are located on the input card directly above the input terminal block. The inputs may be set in one of three configurations:

1. 4-20mA
2. Thermistor, dry contact, or pulse
3. 0-5V

1. To configure the input as 4-20mA, place the shunt to enclose the two bottom pins (B position).

2. To configure the input as thermistor, dry contact, or pulse, place the shunt to enclose the two top pins (A position).

3. To configure the input as 0-5V, remove the shunt.
See Figure 4:

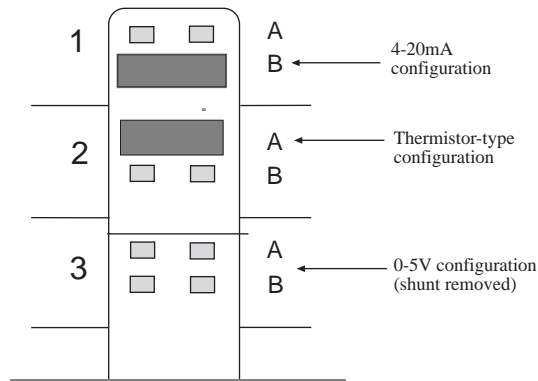

Figure 4: shunt configurations

WIRING THE INPUTS

To use a dry contact or temperature sensor on an input, wire one lead to the numbered screw of input terminal and the other lead to the corresponding common screw. See Figure 5:

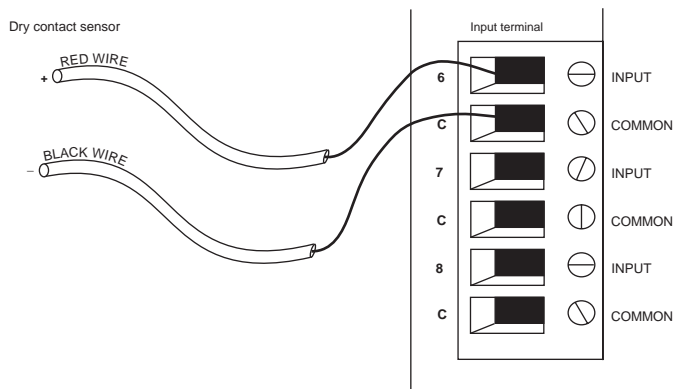

Figure 5: Dry contact sensor

To use a 4-20mA sensor on an input, you must supply power to it. You may power a 4-20mA sensor using the Express II internal power supply, or you may wire the sensor to an external power supply.

To use the *internal* power supply, wire the positive lead from the sensor to the unit 24V power supply. Wire the negative lead to a numbered input terminal screw. See Figure 6.

NOTE: The number of internally powered sensors will affect battery backup time during a power failure.

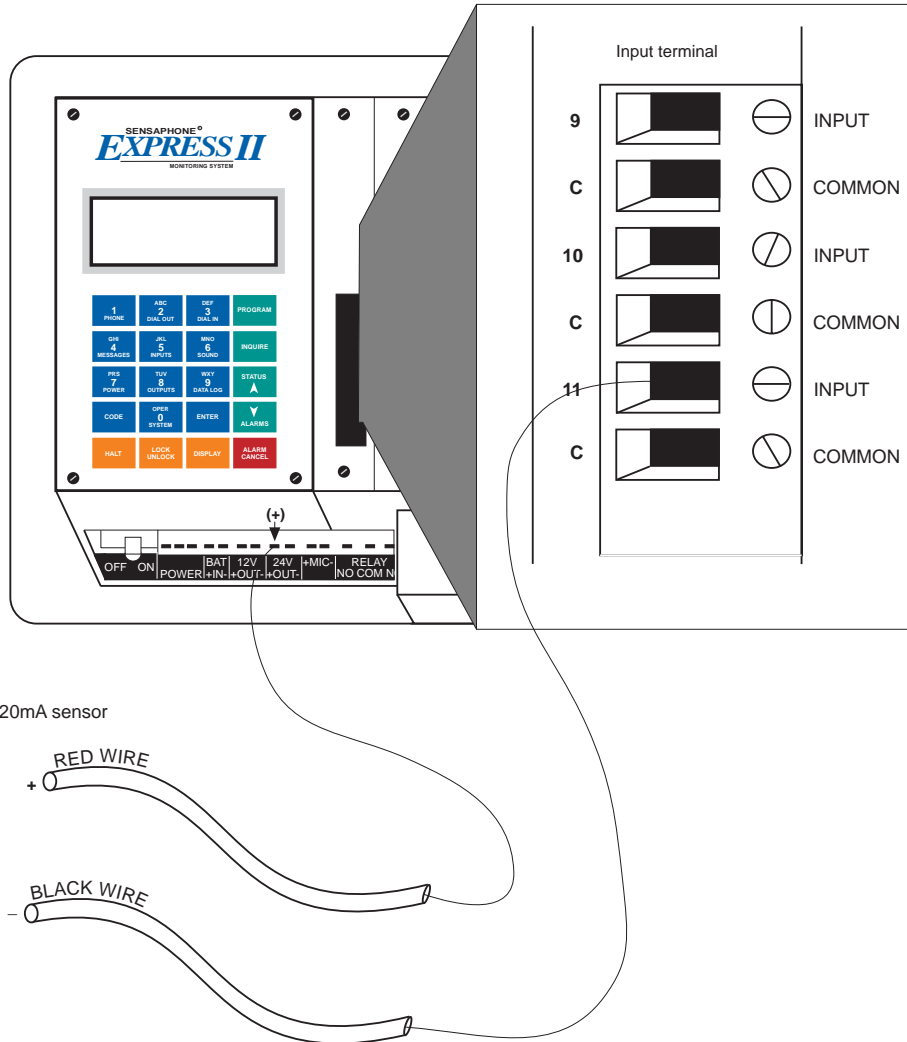

Figure 6: 4-20mA transducer using internal power supply

To use an *external* power supply, wire the positive lead from the sensor to the positive terminal on the external power source. Wire the negative lead from the sensor to a numbered input screw on Express II. Next, connect the power supply to Express II by wiring the negative terminal on the power supply to the corresponding common screw on Express. See Figure 7.

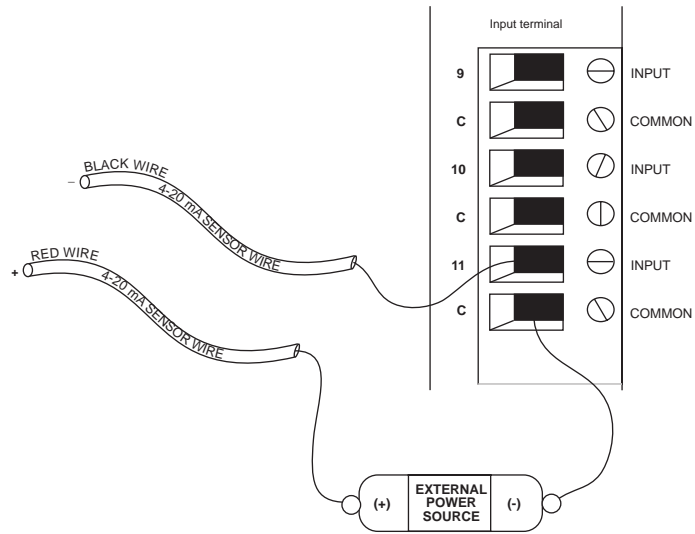

Figure 7: 4-20mA sensor using external power source

To use a 0-5V sensor with Express II, wire the sensor signal lead to a numbered terminal screw on the unit. Then, wire the sensor common to the corresponding common screw on Express II. See Figure 8.

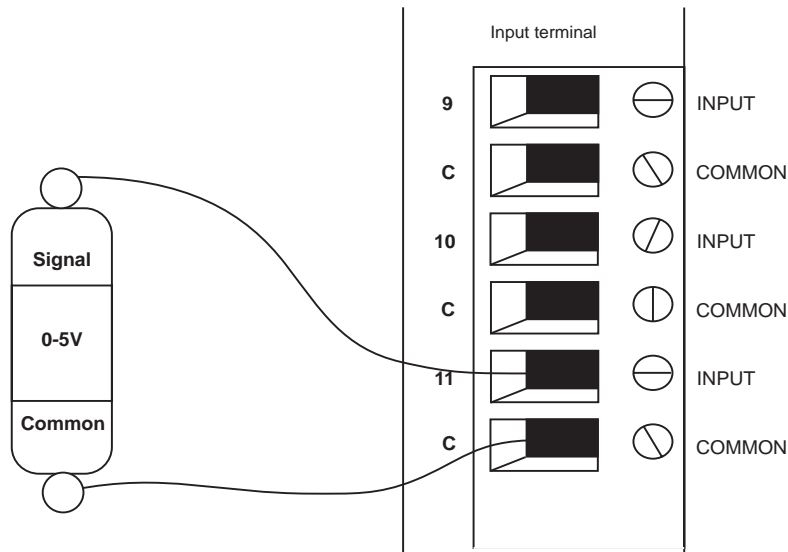

Figure 8: 0-5V sensor

STRAIN RELIEF

Strain relief clamps are provided on the Express II enclosure to prevent wiring from being pulled from the circuit board or damaged when passing through the enclosure. To use the strain relief, thread wires through the clamp and the clear rubber bushing. Position the bushing in the clamp and tighten the screws on either side so that the wiring does not move. See Figure 9 below:

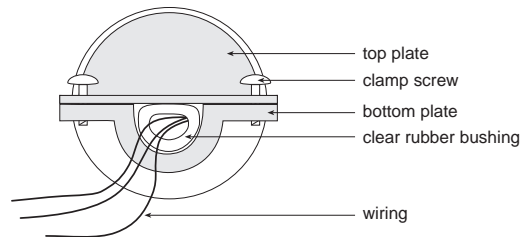

Figure 9: Strain relief clamp

SHIELDED WIRE

Express II is designed to work in most installations without the need for shielded wire. However, this does not apply to wire run outdoors or in conduit that has other noise-generating conductors such as 60 Hz AC. It is strongly recommended that input wiring be run in a conduit separated from AC power or output wiring. When wire runs are long or are in close proximity to large power consuming, power generating or power switching equipment, it is recommended that **shielded wire** be used.

WIRE LENGTH

Temperature - It is recommended that long wire runs be avoided when using a thermistor as a sensor. A long run of wire could alter the resistance of the circuit therefore providing an inaccurate temperature reading of the input. Below is a chart of recommended gauges and wire lengths:

MIN WIRE GAUGE	MAX WIRE LENGTH
#26	250 ft.
#24	700 ft.
#22	1500 ft.
#20	2500 ft.

Dry contact - The total resistance of the loop cannot exceed 50 Ohms. Use the appropriate gauge wire for your application.

Analog current - Long wire runs will not affect the accuracy of the input because there is constant current being driven through the sensor wire.

Analog voltage - Wire runs should be kept as short as possible to avoid voltage drops and noise susceptibility. Use the gauge chart above as a guideline.

NOTE: All wiring should comply with section 17 of the UL requirements.

INSTALLING INPUT EXPANSION CARDS

To install an input expansion card:

1. Turn the unit off. Damage may occur to the motherboard or to the input card if installed while power is still on.
2. Working from left to right, loosen the thumbscrews and remove the blank plate of the first unused slot. See Figure 10 below.

NOTE: Always install cards side by side—do not skip a slot.

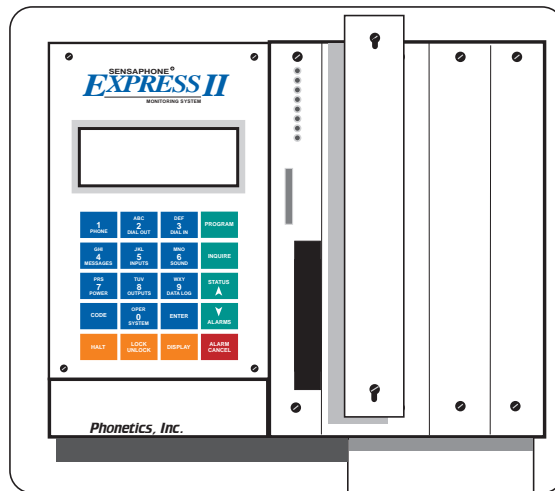

Figure 10: Remove blank plate

3. Hold the card with the LEDs at the top, and line up the DIN connector plug on the card with the DIN connector socket on the motherboard. See Figure 11.

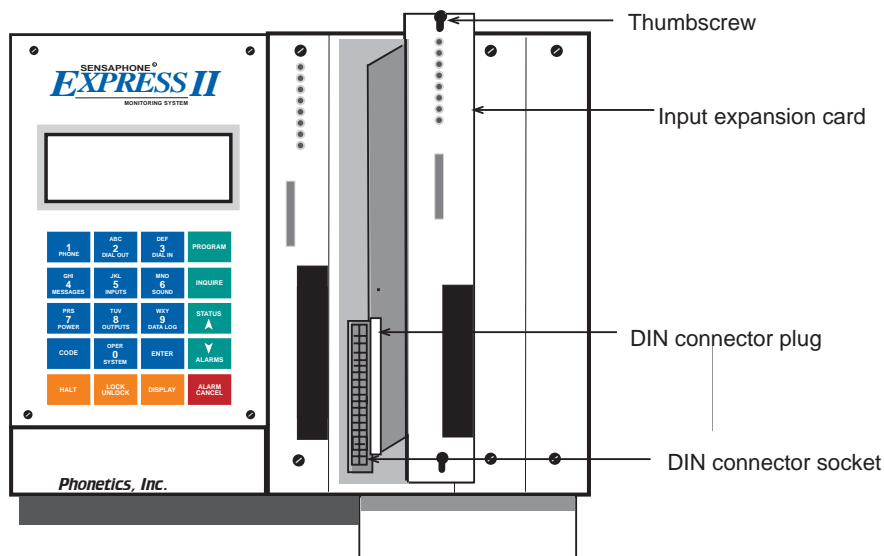

Figure 11: Line up and insert card

4. Insert the DIN connector plug into the DIN connector socket and press down slightly to connect.
5. Re-tighten the thumbscrews.
6. Turn the unit on.
7. Configure and wire the inputs as described in this chapter.

NOTE: When installing a combination of input and output cards, always install the input cards grouped together in the left slots and the output cards to the right of them. If you install an input expansion card after an output card has been installed, you must disconnect the output card, install the input card in its place, and reinstall the output card to the right of it.

INPUT SPECIFICATIONS

Voltage Range:	0 to +5 VDC
Input Resolution:	12 Bit or 0.00122V
A/D Converter Typical Total Unadjusted Error	± 1 LSB
Accuracy (Temperature)	$\pm 1^\circ\text{F}$ typical using 2.8K temperature sensor
Accuracy (4-20mA)	$\pm 1.25\%$
Min/Max Input Voltage	-0.5VDC to +5.5VDC
Max Pulse Frequency	1.0Hz
Noise Filtering	2300Hz low pass filter -20db/Decade



2.8K THERMISTOR LOOK-UP TABLE

DEGREES (Celsius)	DEGREES (Fahrenheit)	RESISTANCE (Ohms)
-50	-58	188.83K
-40	-40	94.47K
-30	-22	49.64K
-20	-4	27.21K
-10	14	15.51K
0	32	9.15K
5	41	7.11K
10	50	5.57K
15	59	4.40K
20	68	3.50K
25	77	2.80K
30	86	2.26K
35	95	1.83K
40	104	1.49K
45	113	1.22K
50	122	1.01K
55	131	0.84K
60	140	0.70K
65	149	0.58K
70	158	0.49K

10K THERMISTOR LOOK-UP TABLE

DEGREES (Celsius)	DEGREES (Fahrenheit)	RESISTANCE (Ohms)
-37	-35	203.60K
-35	-30	173.60K
-32	-25	148.30K
-29	-20	127.10K
-26	-15	109.20K
-23	-10	94.07K
-21	-5	81.23K
-18	0	70.32K
-15	5	61.02K
-12	10	53.07K
-9	15	46.27K
-6	20	40.42K
-4	25	35.39K
-1	30	31.06K
2	35	27.31K
4	40	24.06K
7	45	21.24K
10	50	18.79K
13	55	16.65K
16	60	14.78K
18	65	13.15K
21	70	11.72K
24	75	10.46K
27	80	9.35K
30	85	8.38K
32	90	7.52K
35	95	6.75K
38	100	6.08K
41	105	5.48K
44	110	4.95K
47	115	4.47K
49	120	4.05K
52	125	3.67K
55	130	3.33K
58	135	3.31K
60	140	2.76K
63	145	2.52K
66	150	2.30K
69	155	2.10K
71	160	1.92K
74	165	1.76K
77	170	1.61K
80	175	1.48K
83	180	1.36K
86	185	1.25K
88	190	1.16K
91	195	1.07K
94	200	0.98K
97	205	0.91K

CHAPTER 4: OUTPUTS

Express II comes standard with one on-board relay output. The output capability may be expanded up to 16 relay outputs.

HOW THE OUTPUTS WORK

Relay outputs are used to switch equipment on or off. The 16 expansion outputs can only be operated manually; however, the on-board output may be programmed to operate in two ways: Manual or Auto.

Manual - When configured as manual, the output may be turned on or off by the user. This may be accomplished using the local keypad or via Touch-Tone™ phone.

Auto - The built-in output (Output Zero) is the only output with the "Auto" option available. When this option is programmed, Output Zero will activate when alarm recognition occurs (LED is blinking red) and will deactivate when the alarm has been acknowledged. (Note: the alarm condition may still exist.)

WIRING THE OUTPUTS

The standard on-board relay output, output #0, is located on the orange terminal strip to the far right of the ON/OFF switch (see Figure 12 below).

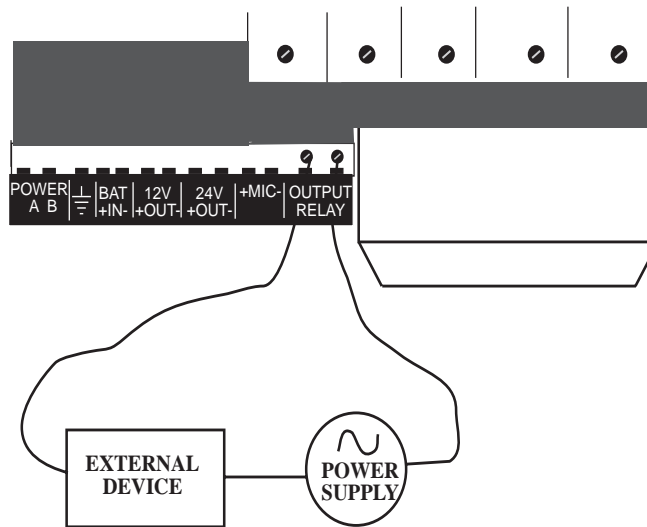

Figure 12: Location of On-board Output relay

It is labeled "Output Relay." It is a single-pole, single-throw, latching relay. See "Outputs" in Chapter Five for more information.

NOTE: All wiring should comply with section 17 of the UL requirements.

STRAIN RELIEF

Strain relief clamps are provided on the Express II enclosure to prevent wiring from being pulled from the circuit board or damaged when passing through the enclosure. To use the strain relief, thread wires through the clamp and the clear rubber bushing. Position the bushing in the clamp and tighten the screws on either side so that the wiring does not move. See Figure 13.

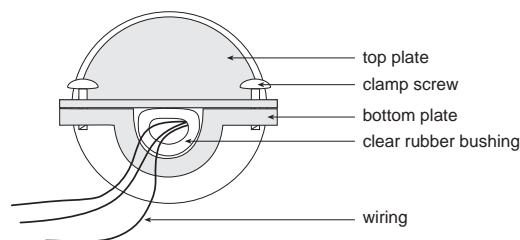

Figure 13: Strain relief clamp

INSTALLING OUTPUT EXPANSION CARDS

To install an output expansion card:

1. Turn the unit off. Damage may occur to the motherboard or to the output card if installed while power is still on.
2. Remove the screws and blank plate of the first available slot from left to right.

NOTE: Always install cards side by side — do not skip a slot.

3. Hold the card with the LEDs at the top with the DIN connector plug on the card lined up with the DIN connector socket on the motherboard.
4. Insert the DIN connector plug into the DIN connector socket and press down slightly to connect.
5. Turn the unit on.

Wire the outputs for the configuration you want--manual or auto--as described above. See Chapter 5 for programming information.

NOTE: When installing a combination of input and output cards, always install the input cards grouped together in the left slots and the output cards to the right of them. If you install an input expansion card after an output card has been installed, you must disconnect the output card, install the input card in its place, and reinstall the output card to the right of it.



RELAY OUTPUT SPECIFICATIONS

TYPE: Latching, SPST
Related Load: 2A at 250VAC
2A at 30VDC
Carry Current: 2A
Maximum Operating Voltage: 250VAC
125VDC
Maximum Operating Current: 2A (AC/DC)
Maximum Switching Capacity: 500VA, 60W



NOTES

CHAPTER 5: PROGRAMMING

Express II features a unique voice-guided, menu-based programming method. Programmable parameters are organized into ten categories, with main menus encompassing several levels of sub-menus. The ten primary categories (designated on Express II's keypad, see fig. 5-1a) are:

- 1 • PHONE - phone contacts information
- 2 • DIAL OUT - outgoing communications
- 3 • DIAL IN - incoming (call-in) communications
- 4 • MESSAGES - alarm, output and ID message recording
- 5 • INPUTS - input configuration
- 6 • SOUND - sound monitoring and listen in
- 7 • POWER - power failure and battery low monitoring
- 8 • OUTPUTS - output control setup
- 9 • DATA LOG - input log and activity log setup
- 0 • SYSTEM - other system parameters

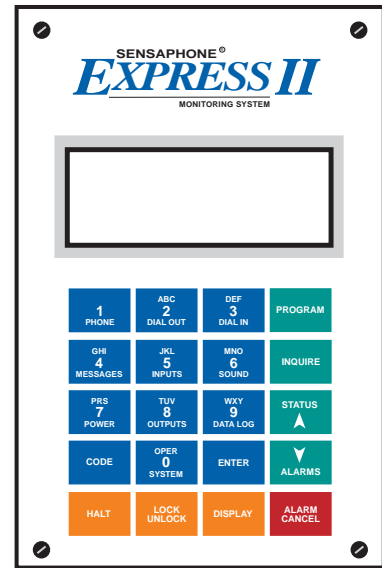

*Figure 5-1a: Express II
Local Display and Keypad*

Programming “How To”: Moving Through the Menus

All programming actions begin by pressing the PROGRAM key, followed by one of the primary category keys (listed above).

These two key presses lead directly to Express II's voice guided instructions, accompanied by text selections shown in the local display. From this point, menu selections are made by pressing the number keys, followed by the ENTER key. Press "0" (zero) to exit any numbered-list menu.

The CODE key allows you to navigate between menus during programming. To repeat a menu while programming, press the CODE key once. To return to a previous menu, press the CODE twice.

To return to the main menu at any time, press CODE until the main menu is reached.

You may also make your programming selections using the local display. Each option conveyed through an audible voice message will also be listed as text on the local display. If you press the arrow keys on the keypad, an arrow will appear next to a selection (if it is not already present, as in some selection listings). This arrow can be repositioned next to any of the options by pressing the down arrow on the ALARMS key. To move back up the list, press the up arrow on the STATUS key. When the arrow appears next to your selection, press the ENTER key.

In the demonstrations that follow, each illustrated sequence shows how options are selected from a list, while moving through Express II's multilevel menu system.

Programming PHONE Parameters [1]

The PHONE parameters allow you to program when, how and to which location Express II will dial out during an alarm. Express II is capable of dialing out to 48 different locations.

Phone parameters are divided into two separately-programmed categories— Calling Schedule and Phone Contacts. We'll deal with Communications Type a little later.

1. **Calling Schedule** – the day and time settings during which specified groups of Phone Contacts will be called, in the event of an alarm.
2. **Phone Contacts** – the telephone numbers to which Express II will dial out, in the event of an alarm. Up to 48 telephone numbers can be used, and may include Special Dialing codes.

1. Calling Schedule

Calling Schedule allows you to assign Phone Contacts to specific calling groups to accommodate shift work schedules. Time is measured using the “24 hour” format. There are 3 calling schedules from which to choose. The default is “All,” indicating that no grouping of Phone Contacts is in effect and that dial-out will occur around the clock, at all times. Selecting Calling Schedule brings up the following choices:

1. All

This schedule programs Express II to call all the Phone Contacts that are programmed regardless of the time of day, or day of week. This is the default setting. Phone Contacts from 1-48 are called regardless of time, day or day of week

2. Days and Nights

This schedule allows Express II to create two groups for dialing out: a daytime set of Phone Contacts (Monday to Friday), and a nighttime/weekend set of Phone Contacts (Friday night to Monday morning).



Figure 5-1: Express II Local Display and Keypad

PHONE PARAMETERS

Calling Schedule:

- 1) Press PROGRAM



- 2) Press PHONE.



- 3) A new list appears in the local display.

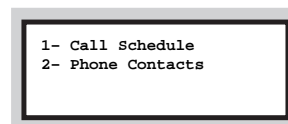

Press 1 for Call Schedule.



- Phone Contacts from 1-24 are called during the day (Monday to Friday).
- Phone Contacts from 25-48 are called during the night and weekend.

3. Day, Night, Wknds

This schedule allows you to program Express II to call a set of Phone Contacts during the day (Monday to Friday), a set of Phone Contacts during the night (Monday to Thursday), and a set of Phone Contacts for the weekend (Friday night through Monday morning).

- Phone Contacts from 1-16 are called during the day (Monday to Friday).
- Phone Contacts from 17-32 are called during the night (Monday to Thursday).
- Phone Contacts from 33-48 are called during the weekend (Friday night to Monday morning).

Day and night starting times are separately programmed to control how Express II differentiates day and night periods.

Programming Day and Night Starting Times

If option 2 (Days and Nights), or 3 (Day, Night and Wknds) was selected, then you will be prompted to set the starting times for day hours/minutes and night hours/minutes. After you have separated your Phone Contacts into groups, setting the day and night starting times allows you to define when one shift ends and another begins. This way, dial-out can occur in any 24 hour period, to report an alarm around the clock.

It is important to note that time is programmed using the "24 hour" format: A day hour set to "5" is equal to 5:00 am. A night hour set to "17" is equal to 5:00 pm. The default setting is 7 hours, 0 minutes for day hours, and 19 hours, 0 minutes for night hours.

24-Hour Time: PM Conversion					
1:00 pm	equal to	13 hours	7:00 pm	equal to	19 hours
2:00 pm	equal to	14 hours	8:00 pm	equal to	20 hours
3:00 pm	equal to	15 hours	9:00 pm	equal to	21 hours
4:00 pm	equal to	16 hours	10:00 pm	equal to	22 hours
5:00 pm	equal to	17 hours	11:00 pm	equal to	23 hours
6:00 pm	equal to	18 hours			

- 4) A new list appears in the local display. Select one option:

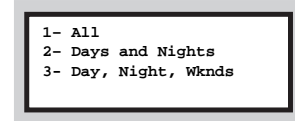

Press **1** if selecting All.



Press **2** if selecting Days and Nights.



Press **3** if selecting Day, Night, Wknds.



- 5) If option **2** or **3** is selected, current starting times, first for day, and then for night, will be displayed, along with the option to reset these times. **To keep current settings, just press the ENTER key.**

To change settings, use the number keys on the keypad and press ENTER. When Express II says, "Enter day hours," enter the hour (0 to 23); then press ENTER. The new hour will appear in the local display.

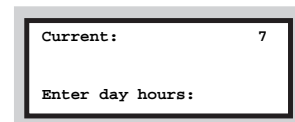

When Express II says, "Enter day minutes," enter the minutes (0 to 59); then press ENTER.

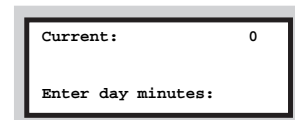

2. Phone Contacts

Express II can store up to 48 telephone numbers, with up to 40 digits permitted for each one. These numbers will be dialed in the event of an alarm. Special dialing codes that reflect a pause, pound, asterisk or other similar code may be incorporated into the telephone number as required, to access various phone and beeper systems.

Once you've set the schedule times, choose "2" from the previous menu to select Phone Contacts. Remember that you can program up to 48 phone numbers (contacts); however, if you are using a calling schedule other than ALL, you will have to program those phone numbers in the appropriate group of contact numbers (e.g., Contact numbers 1-24 for day, 25-48 for night & weekend). Note that all contact numbers in the group will be called in numerical order, so *program the most important numbers first*. If you want someone called regardless of time of day, simply program that phone number in each contact group.

On the "Enter Phone Number Selection" screen, select the contact number you want to program by pressing a number or set of numbers on the keypad, followed by the [Enter] key.

The Express II will then give you a choice between two types of phone calls for it to make.

Communications Type

Express II is capable of dialing out over standard telephone lines in either Voice or Beeper mode. When dialing out in Voice mode, Express II will recite the prerecorded alarm message when its outgoing call is answered. The default setting is Voice.

When Dialing out in Beeper mode, no message will be recited. The Express II delivers a Touch-Tone code message to your beeper or pager. The two choices come up as:

- 1 - Voice
- 2 - Beeper

Special Dialing Codes

Special Dialing Codes are commonly used when accessing a beeper or pager system, or in order to reach a dial tone for connection to an outside line. To incorporate a Special Dialing Code into the phone number you are programming, press the blue CODE

- 6) Next, current starting times for night hours and night minutes are displayed, along with the option to reset these times. **To keep current settings, press the ENTER key.**

To change settings, use the number keys on the keypad and press ENTER. When Express II says, "Enter night hours," enter the hour (0 to 23); then press ENTER. (Remember..."19" is the same as 7:00 pm, using a 24-hour system.)

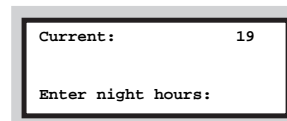

When Express II says, "Enter night minutes," enter the new time; then press ENTER.

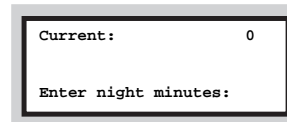

Phone Contacts:

After the Call Schedule has been set, the local display returns to the previous menu.

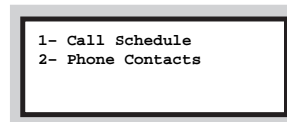

- 1) Press 2 for Phone Contacts.



key, followed by the corresponding number key from the list below. Insert the code or combinations of codes where required in the telephone number.

Code 1

Generates a two second pause.

Code 2

Waits for a dial tone before proceeding.

Code 3

Inserts a "T" command. The voice will say "Tone dial." This is specifically for connection to a beeper from a rotary (pulse) phone line. Type in the phone number for the beeper service, followed by [Code 1] [Code 3] followed by the beeper number and the alarm characters (see Code 5). The "T" code turns all numbers following it into Touch-tones, which the beeper requires.

Code 4

Forces the Express II to wait until the telephone is answered.

Code 5

Sends two digits to appear on the display of a beeper or pager, indicating which input is in alarm.

NOTE: This information must come at the end of the phone number string. (See Example below)

EXAMPLE: At "Enter Phone Number," you would type in: 18005551839 [Code1] [Code1] 5556488 [Code5] [Code6] [Enter]. The first string is the beeper number, followed by two two-second pauses, followed by the Express II's phone number, followed by the Code 5, which is where the number of the first alarm will show up, followed by a Code 6 to "close" the dialing string, followed by "Enter" to end it.

Code 6

Sends the pound (#) , as required in some dialing sequences.

Code 7

Sends the asterisk (*), as required in some dialing sequences.

To *clear* a programmed phone number, select the same priority number you've chosen for that number (Program/Phone Contacts/Phone Number Selection) and simply press "Enter" when prompted to "Enter Phone Number."

- 2) Allocate a number to each contact, assigning them a position in the calling schedule. Assign phone contact a position number (1-48). Enter the number corresponding to that position using the number keys. Then press the ENTER key.

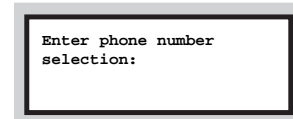

"phone number selection" refers to the contact's position number.

(Keep in mind the Calling Schedule currently in place, since this determines when a Phone Contact is able to dial out.)

- 3) When the Phone Contact has been assigned a number value, two choices appear in the local display. Using the number keys, select the appropriate option.

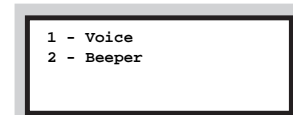

- 4) Now that Voice or Beeper mode has been established, the local display prompts you to enter the complete dial-out telephone number. Up to 40 digits are possible, including 1 and the area code, or any Special Dialing codes that are required to reach the target telephone or beeper system.

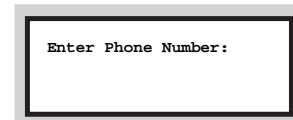

When the complete dial-out telephone number is entered, press the ENTER key.

The local display returns to the previous menu. Repeat steps shown above to program additional Phone Contacts.

To return to the main menu, press CODE twice.

DIAL OUT [2]

The following parameters control how Express II communicates when it dials out for an alarm.

1. Dialing Method - This parameter determines whether Express II will dial out using tone or pulse dialing. The programming choices for this parameter are Pulse, Tone, or Automatic.

Automatic instructs Express II to determine whether to dial out in tone or pulse automatically.

NOTE: You must have a dedicated phone line for Express II to use the Automatic method. If you have Express II installed on an office system that requires dialing an access number to reach an outside line, you **MUST** program this parameter as Tone or Pulse.

The default setting is AUTOMATIC. The choices under "Dialing Method" are:

1 = Pulse; 2 = Tone; 3 = Automatic.

2. Retries on Busy - This determines how many times Express II will hang up and attempt to recall a phone number when it detects a busy signal. This parameter may be programmed from 0-15. The default is 0. NOTE: Each retry applies toward the Maximum number of calls.

3. Message Repeat - When Express II dials out and the call has been answered, this parameter determines how many times the unit will recite the recorded alarm message per call. This parameter may be programmed from 0 to 10 repetitions. The default is 3.

4. Maximum Number of Calls - This parameter determines the maximum number of calls Express II will make if the unit does not receive acknowledgment. The maximum calls may be programmed from 0 to 65,535. The default is 100. If the Express II has only one phone number programmed to dial out for a particular alarm, it will limit the maximum calls to 15 regardless of the Maximum number of calls programmed.

5. Call Delay Time - This parameter is the length of time that Express II will wait after an alarm is recognized before it starts the dial out sequence. (Note: This is not the same as input recognition time.) The call delay time dictates the delay before the *first* call. To set the delay time between calls, see Intercall Delay Time. This parameter may be programmed from 0 to 12 hours. The default for the call delay time is 30 seconds. During call delay, the unit will announce the message locally.

DIAL OUT PARAMETERS

1-Dialing Method:

- 1) Press PROGRAM.



- 2) Press DIAL-OUT.



DIAL-OUT menu will then appear on local display.

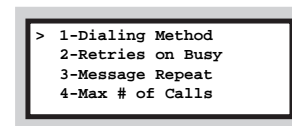

- 3) Press 1 for Dialing Method.



Press 1 for Pulse.

Press 2 for Tone.

Press 3 for Automatic.

2-Retries on Busy:

Return to Dial-Out menu.

- 1) Press 2 for RETRIES ON BUSY.



- 2) Press the amount of retries desired using the number keys. Press ENTER.



3-Message Repeat:

Return to Dial-Out menu.

- 1) Press 3 for MESSAGE REPEAT.

DIAL IN [3]

The following parameters determine how Express II will communicate when the unit is called.

1. Rings Until Answer - This parameter determines the number of rings that must occur before Express II will answer. This value can be from 1 to 15. The default is 1 ring.

2. Telephone Answering Device compatibility (TAD) - Express II can be used on the same telephone line that also has a telephone answering device, such as an answering machine, modem or FAX. The TAD feature is especially useful because it integrates the operation of the Express II with your telephone answering device in a way that retains the full flexibility of each system. This allows you to have on-demand telephone access to the Express II, for obtaining a Status Report, or for issuing call-in commands, while your telephone answering device is set to receive outside calls. Programming for use with a telephone answering device (TAD) is always used in conjunction with RINGS UNTIL ANSWER, detailed on this page.

NOTE: The TAD feature only applies to answering devices connected to the same telephone line as the Express II.

USING TAD:

By enabling this feature, you will be able to bypass the answering device and access Express II for a status report or programming. If there are no other devices hooked up to the phone line, this feature should be disabled. The default is disabled.

- 1) Make sure the TAD feature is enabled. The default setting is disabled, so you must enable it initially.
- 2) Determine the number of rings your telephone answering device uses to answer the telephone. Most answering devices require 4 rings; others are selectable.
- 3) Program the Express II RINGS UNTIL ANSWER to a greater number than that of the number of rings set on your answering device.

Example:

Telephone answering device: rings = 4.

Express II: RINGS UNTIL ANSWER = 6.

DIAL IN PARAMETERS

1-Rings Until Answer:

- 1) Press Program.



- 2) Press DIAL IN.



DIAL IN menu will appear on local display.

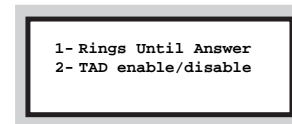

- 3) Press 1 for RINGS UNTIL ANSWER.
- 4) Enter the number of rings desired before EXPRESS II answers.(1-15)

Read section on TAD, pg. 26 - 27, before programming RINGS UNTIL ANSWER.

2-TAD enable/disable:

Return to DIAL IN menu.

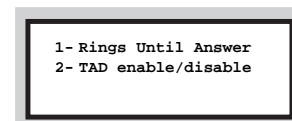

- 1) Press 2 for TAD.
- 2) Press 1 to disable.
Press 2 to enable.



Calling Express II with TAD Enabled

To have the Express II answer the phone with a Telephone Answering Device on the same line, call the unit's telephone number and let the line ring once, then hang up. Wait several seconds and then call back again. The Express II will answer the line on the first ring, bypassing your answering machine.

Explanation: The pattern of one ring, followed by a second call (within 30 seconds), signals the Express II to answer your incoming call, excluding the telephone answering device.

NOTE: If the Express II unit shares the same telephone line with a Telephone Answering Device, and during certain time periods frequent incoming calls are expected on that line, then you may want to temporarily disable the TAD feature. If you leave the TAD enabled, it will not adversely affect normal operation, but if two outside telephone calls are received within the same 30 second time window, the Express II unit will interpret this pattern as a signal to answer the telephone. If this occurs, press the ALARM/CANCEL key on the unit to hang up.

MESSAGES [4]

Recording your own messages provides a valuable, expeditious communication link between the Express II and service personnel.

Voice messages - Express II allows you to program your own voice for the ID (identification) and dial-out alarm messages. This means that when Express II calls you or someone on your staff during an alarm, your personalized voice message will indicate exactly which alarm condition exists. Depending on what the input is monitoring, you might program a warning message, or provide brief vital monitoring data.

The voice message choices are:

- 1 - Record ID Message (default length: 10 seconds)**
- 2 - Record Input Message (default length: 5 seconds)**
- 3 - Record Output Message (default length: 5 seconds)**
- 4 - Message length**

The ID Message allows you to identify the Express II and/or the system it's monitoring as the caller.

The Input Message is the alarm message corresponding to each specific input that the Express II is monitoring. You must program this by entering the number of the Input (1-8 on the first card, etc.) to identify it, and then recording the relevant alarm message for it.

The Output Message feature can only be used if you've purchased and installed an Output Card in the Express II.

Message length - This parameter determines how many seconds long each message can be. A message can be 5, 7, or 11 seconds long. However, you can cut any message short if you finish recording it, by pressing [Enter].

(Note: The shorter the message length, the better the quality of the recording. We recommend that you program this parameter to 5 seconds for optimum clarity.)

NOTE: Do not change the message length parameter after you have recorded voice messages. If you do so, you will automatically erase all programmed voice messages and reset them to the default.

MESSAGE PARAMETERS

Messages:

- 1) Press Program.



- 2) Press Messages.



Messages menu will then appear on local display.

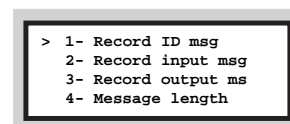

- 4) Press 1 to record ID message.
Speak message after beep.
- 5) Press 2 to record input messages.
Enter the input number to which the message corresponds.
Speak message after beep.
- 6) Press 3 to record output message.
Enter the output number to which the message corresponds.
Speak message after beep.
- 7) Press 4 for message length.
Enter 5, 7, or 11.(the default is 5)
Messages can be cut short by pressing Enter during recording.

INPUTS [5]

Express II comes standard with 8 universal inputs. The input capacity may be expanded up to a total of 40 universal channels. The following parameters determine how each input functions. The parameters apply to both the standard and expanded inputs.

1. Enable/Disable Inputs - This function allows you to enable or disable an alarm on an input to cause a dial out. An enabled input will respond to an alarm and allow dial out. A disabled input will not initiate a dial out if an alarm occurs. The default setting for all inputs is enabled.

2. Input Type - Express II's inputs are universal inputs. This means that they may be configured to accept the following type sensors:

- 1 = Normally closed dry contact (digital)
- 2 = Normally open dry contact (digital)
- 3 = Pulse count (counts to 65,535 then resets to zero)
- 4 = 4-20 mA (analog)
- 5 = 0-5 Volts (analog)
- 6 = Temperature (thermistor):
 - 1) 2.8K F thermistor (analog)
 - 2) 2.8K C thermistor (analog)
 - 3) 10K F thermistor (analog)
 - 4) 10K C thermistor (analog)
- 7 = Time accumulator

The default input type is 2 (normally open dry contact)

3. Input Recognition Time - The input recognition time is the length of time an input must have an alarm continuously before Express II will recognize the condition. If an alarm is tripped and then clears within the recognition time, it is not recognized as a valid alarm. Express II will not dial out. This feature is useful to prevent dial outs for momentary blips or on self-correcting equipment. Each input can be programmed with a different recognition time. You may program the recognition time from 0 seconds to 12 hours. The default is 3 seconds.

INPUT PARAMETERS

The first step in programming the INPUT parameters is to enter the number of the input for which you intend to program.

- 1) Press Program.



- 2) Press Input.



- 3) Press the input number(1-40).

Press Enter.

The **Input menu** will then appear on the local display.

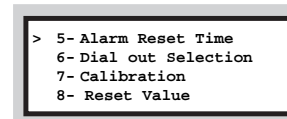
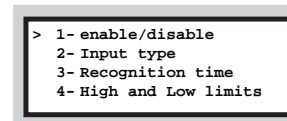

1-Enable/Disable Inputs:

- 1) At the Input menu, select Enable/disable by pressing 1 on the keypad. Or, by pressing arrow keys until the ">" symbol, on the local display, is next to Enable/disable.
- 2) Press 1 to disable.
Press 2 to enable.

2-Input Type:

- 1) Press 2 at the Input menu, to select Input Type.(or on local display as described in Enable/disable inputs)

A list of Input Types will then appear on the local display.

4. High and Low Limits - Express II allows you to program high and low limits for inputs defined as an analog input type or pulse count. Inputs defined as normally open or normally closed cannot be programmed to have high or low limits. During voice prompted programming, high and low limits will only be prompted when the input is defined as an analog type or pulse count. The limits are -9999 to +9999. Express II defaults to these limits.

NOTE: The Pulse Count Low Alarm Limit is set at -1. You cannot go below zero on a pulse count, but the *Alarm* limit is -1 to be distinct from the possible value of 0. DO NOT change this Low Limit.

5. Alarm Reset Time - After an alarm is acknowledged, Express II stops the dial out sequence. However, the alarm condition will still exist until the alarm clears itself or some action occurs to clear the alarm. If the alarm is not cleared after a certain amount of time, Express II can be programmed to restart the dial out sequence. This is called the alarm reset time. This parameter may be programmed from 0 seconds to 12 hours.

Setting the alarm reset time to 0 seconds will disable it. This means that once the alarm has been acknowledged, it will not retrip an alarm regardless of how long it exists. The default for this parameter is 0 seconds.

For example, you program the alarm reset time for input 1 to 2 hours. An alarm occurs on input 1 and Express II dials out. The alarm is acknowledged but the condition still exists. Two hours later, the alarm condition still has not been cleared. Express II will restart the dial out.

6. Dial Out Selection - You may program Express II to dial specific phone contacts according to which input is in alarm. This is the Dial Out Selection. For example, input 6 can be programmed to initiate calling to Phone Contact 1, 3, 4, and 16. Meanwhile, an alarm on input 2 can initiate calling to Phone numbers 2 - 13. This parameter allows you to have specialized personnel being called only for specific alarms. To return to the default, all contacts, press '9' '9' and then press ENTER.

```
> 1- Normally closed
  2- Normally open
  3- Pulse count
  4- 4-20 mA
```

```
5- 0-5 Volts
> 6- Temperature
  7- Time accumulator
```

2) Key in the appropriate Input type.

(the default is 2; normally open dry contact)

Press **1** for **normally closed**.

Press **2** for **normally open**.

Press **3** for **pulse count**.

Press **4** for **4-20 milliamp**.

-Enter table low limit, press Enter.

-Enter table high limit, press Enter.

Press **5** for **0-5 Volts**.

-Enter table low limit, press Enter.

-Enter table high limit, press Enter.

Press **6** for **temperature**.

-Press 1 for 2.8K °F thermistor.

-Press 2 for 2.8K °C thermistor.

-Press 3 for 10K °F thermistor.

-Press 4 for 10K °C thermistor.

Press **7** for **time accumulator**.

3-Recognition Time:

1) Return to Input menu. Press 3 for Recognition Time.

2) Enter hours.

Enter minutes.

Enter seconds.

4-High/Low Limits:

1) Return to Input menu. Press 4 for High/Low Limits.

2) Enter low limit.

7. Calibration - This feature works for analog inputs (4-20mA, 0-5 volts, or temperature) only. The default analog setting is 1.000. The calibration feature acts as a multiplier of that value.

Pressing [Program] increases the reading in increments of .01 (hundredths).

Pressing [Inquire] decreases the setting in increments of .01.

Pressing [Status/Up Arrow] will increase it by .001 (thousandths).

Pressing [Alarm/Down Arrow] decreases it by .001.

If, for example, your current temperature is 75° but the Express II is reading 72°, you would recalibrate by pressing the Program and/or Status keys to raise it. As you'll see if you use this feature, it takes very little increase in the multiplier to raise the value. With the four keys, you can fine tune the calibration to the exact reading you want. When done calibrating, press [Enter] to set.

8. Reset Value - Although both Pulse Count and Time Accumulator inputs have ultimate values (65,535 for Pulse Count; 99:59:59 for Time Accumulator) after which they wrap automatically to zero, you will likely want to reset the count to zero before that value is reached. Selecting the Reset Input Value and pressing [Enter] clears the values to zero.

NOTE: Each input's set of parameters can be programmed independently of the other inputs. But the input number must be entered *before* programming the parameters.

Enter high limit.

5-Alarm Reset Time:

- 1) Return to Input menu. Press 5 for Alarm Reset Time.
- 2) Enter hours.
Enter minutes.
Enter seconds.

6-Dial Out Selection:

- 1) Determine the Dial Out Selection for each input before you begin programming.
- 2) Return to Input menu. Press 6 for Dial Out Selection.
- 3) Enter list of dial out selection.
Press individual position numbers. (1-48)
Press Enter.
- 4) When all position numbers in list are entered, press Enter again.
- 5) The default is all contacts.
Press '9' '9' for the default.

7-Calibration

- 1) Determine that the input you want to calibrate is one of the analog types.
- 2) Using the Program and Status keys to increase the value, and Inquire and Alarms to decrease it, adjust the value of your input until it reads correctly.
- 3) Press Enter to set this value.

8-Reset Value

- 1) Select an input. Determine that it is either Pulse Count or Time Accumulator. Press Enter.
- 2) Press "8." Press Enter. The value is returned to "0".

SOUND [6]

Express II allows you to listen to sound levels through its built-in microphone when you call in for a status report. Express II also monitors the sound levels through its built-in microphone. When the current sound level suddenly exceeds the normal sound level, Express II can be programmed to dial out with a high sound alarm.

1. Listen-in Time - The listen-in time is the amount of time you can listen to sounds at the microphone site when you call in for a status report. The programming range is from 0 to 255 seconds. The default time is 15 seconds.

2. Enable/disable Sound Monitoring - This parameter determines whether Express II will initiate the dial out sequence if it detects a high sound. If the sound is enabled, Express II will dial out. If the sound is disabled, Express II will not dial out for high sound. 1 = enabled; 0 = disabled. The default is enabled.

3. Sound Sensitivity - This parameter allows you to change the sensitivity of the sound monitoring. This may be useful to desensitize Express II if it is installed in an area with relatively high sound level, or where loud noises occur but are not associated with an alarm. Also, this feature allows you to increase sensitivity in situations where you want to monitor lower sound levels. The sensitivity range for sound alarm monitoring is 1 to 100. A value of 1 is the most sensitive; 100 is the least sensitive. The default is 50.

4. Sound Recognition Time - The sound recognition time is the length of time that a high sound condition must exist continuously before Express II will recognize the condition. If the high sound stops before the recognition time is up, it is not recognized as a valid alarm. Express II will not dial out. This feature is useful to prevent dial outs for momentary occurrences of high sound. You may program the recognition time from 2 seconds to 1 minute. The default is 8 seconds.

5. Sound Alarm Reset Time - After a sound alarm is acknowledged, Express II stops the dial out sequence. However, the high sound condition will still exist until the alarm clears itself or some action occurs to clear the alarm. If the high sound is not cleared after a certain amount of time, Express II can be programmed to restart the dial out sequence. This is called the sound alarm reset time. This parameter may be programmed from 2 seconds to 12 hours.

SOUND PARAMETERS

1) Press Program.



2) Press Sound.



The Sound Parameters menu will then appear on the local display.

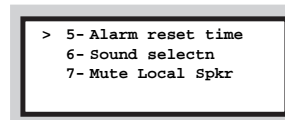
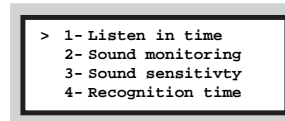

1-Listen-in Time:

- 1) Press 1 for Listen-in Time.
- 2) Enter seconds.(0-255)

2-Sound Monitoring:

- 1) Press 2 for Sound Monitoring.
- 2) Press 1 to enable.
Press 0 to disable.

3-Sound Sensitivity:

- 1) Press 3 for Sound Sensitivity.
- 2) Enter value.(0-100)

4-Recognition Time:

- 1) Press 4 for Recognition.
- 2) Enter hours.
Enter minutes.
Enter seconds.

POWER [7]

Express II monitors AC power failure and low battery condition. Power monitoring and low battery monitoring is explained below.

1= AC Power

2= Battery

Power Failure

1. Power Failure Monitoring enable/disable - This command enables or disables the power failure detection. When enabled, Express II will monitor power and dial out if a valid failure occurs. When disabled, Express II will not dial out for a power failure. 1 = disable, 2 = enable. The default is enabled.

2. Power Recognition Time - The power recognition time is the length of time that a power failure must exist continuously before Express II will recognize it as an actual alarm and initiate the dial out sequence. Power recognition time may be programmed from 0 seconds to 12 hours. The default is 5 minutes.

3. Alarm Reset Time - After power failure is acknowledged, Express II stops the dial out sequence. However, the power failure condition will still exist until power is restored. If the power is not restored after a certain amount of time, Express II can be programmed to restart the dial out sequence. This is called the alarm reset time. This parameter may be programmed from 0 seconds to 12 hours.

If the alarm reset time is programmed to 0 seconds, the feature is disabled. Express II will not restart the dial out regardless of how long the alarm exists.

4. Dial Out Selection - You may program Express II to call a specific set of Phone Contacts for power failure only. This is called the Dial out selection. To return to the default setting, all contacts, press '9' '9', and then press ENTER.

POWER PARAMETERS

AC POWER

- 1) Press Program.



- 2) Press Power.



- 3) Power menu will appear. Press 1 for AC Power Parameters.

The AC Power menu will then be displayed.

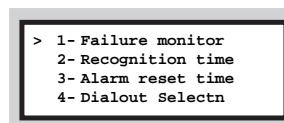

1-Power Failure Monitoring:

- 1) At the AC Power menu press 1 for Failure Monitor.
- 2) Press 1 to disable.
Press 2 to enable.

2-Power Recognition Time:

- 1) Press 2 at the AC Power menu.
- 2) Enter hours.
Enter minutes.
Enter seconds.

3-Alarm Reset Time:

- 1) Return to the AC Power menu. Press 3 for Alarm Reset time.
- 2) Enter hours.
Enter minutes.
Enter seconds.

4-Dialout Selection:

- 1) Press 4 at the AC Power menu for Dial Out Selection.

Battery Low

1. Battery monitoring enable/disable - This command enables or disables the battery low detection. When enabled, Express II will monitor battery condition and dial out if it becomes low. When disabled, Express II will not dial out for a battery low condition. The default is disabled.

2. Alarm reset time - After battery low condition is acknowledged, Express II stops the dial out sequence. However, the low battery condition will continue to exist until it is recharged. If the battery is not recharged after a certain amount of time, Express II can be programmed to restart the dial out sequence. This is called the alarm reset time. This parameter may be programmed from 0 seconds to 12 hours.

If the alarm reset time is programmed to 0 seconds, the feature is disabled. Express II will not restart the dial out regardless of how long the alarm exists.

3. Dial Out Selection - You may program Express II to call a specific set of Phone Contacts for battery low only. This is called the Dial out selection. To return to the default, all contacts, press '9' '9', and then press ENTER.

- 2) Enter the list of position numbers, (1-48), for those contacts to be dialed by Express II in the event of AC Power Failure.(Failure monitor must be *enabled*.)
- 3) Enter list of dial out selection.
Press individual position numbers. (1-48)
Press Enter.
- 4) When all position numbers in list are entered, press Enter again.
- 5) The default is all contacts.
Press '9' '9' for the default.

BATTERY

- 1) Return to the Power menu. Press 2 for Battery Parameters.

The Battery menu will then be displayed.

```
> 1- Battery monitor
  2- Alarm reset time
  3- Dialout selectn
```

1-Battery monitor:

- 1) Press 1 for Battery monitor at the Battery menu.
- 2) Press 1 to disable.
Press 2 to enable.

2-Alarm reset time:

- 1) Return to the Battery menu. Press 2 for Alarm Reset Time.
- 2) Enter hours.
Enter minutes.
Enter seconds.

3-Dialout selection:

- 1) Press 3 for Dial Out Selection at the Battery menu.
- 2) Enter the list of position numbers, (1-48), for the phone contacts to be dialed by Express II in the event of Battery Failure.(Battery monitor must be *enabled*.)

3) Enter list of dial out selection.

Press individual position numbers.
(1-48)

Press Enter.

4) When all position numbers in list are entered, press Enter again.

5) The default is all contacts.

Press 99 for the default.

OUTPUTS [8]

Up to 16 outputs may be installed in Express II.

1. Manual - This type of output is turned on/off manually by the user. It is available only if you purchased an output card for the Express II. These cards look no different than the Input cards you can add and are installed the same way.

2. Auto-any alarm - Output #0, which comes built into the unit, can be switched on automatically when alarm recognition occurs, and off again when the alarm is acknowledged. The condition causing the alarm may still exist, but the auto-alarm will be off. (See Figure 11 for location of this Output Relay.)

Outputs may be useful if you want to have equipment hooked up to the Express II. For instance, if the unit is monitoring temperature in a particular environment, you might have a fan or heater hooked up to an output, which you could switch on over the phone if the temperature exceeded prescribed parameters.

See Chapter Four for more information on Outputs.

OUTPUT PARAMETERS

1) Press Program.



2) Press Output.



3) Enter output number (0-16).

4) Press 1 for manual.

Press 1 for OFF.

Press 2 for ON.

5) Press 2 for automatic-any alarm. Only for output # 0.

DATA LOG [9]

Express II has two logging features, the Input Log and the Activity Log. The Data Log features require the use of a printer with a serial port. If either data log is enabled, Express II will send information to the serial port to be printed via the RS232 socket located to the right of the phone jack and above the orange terminal block at the bottom of the unit.

1. Input/Output Log - Logs the input (or output) values on a user-defined basis. The menu offers four choices:

1. Enable/Disable: 1=disable; 2=enable

2. Time between logs: set the hours, minutes, and seconds. The minimum allowed time is 5 seconds; the maximum is 12 hours, 59 minutes, 59 seconds.

3. Number of inputs: the maximum this can be set to is 40.

4. Line length: this determines the number of characters that a data log printout will allow on each line. The default setting is 80 characters per line. Check your printer setup before changing this number.

2. Activity Log - Logs all system and alarm activity. This includes programming changes, alarms occurring and clearing, acknowledgments, any call-ins to the unit and alarm dial outs.

NOTE:

Once datalogging is enabled, the system will automatically default to an RS232 rate of 9600 baud. If your target printer is not configured to 9600 baud, refer to your printer manual to adjust the printer's baud rate. (See also "Unit configuration" in the following section.)

DATA LOG PARAMETERS

1-Input/Output Log:

1) Press Program.



2) Press Data Log.



Data Log menu will appear on local display.

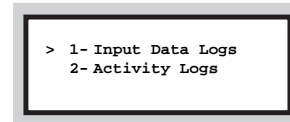

3) Press 1 for Input/Output Log.

4) Press 1 for Enable/Disable.

Press 1 to Disable; 2 to Enable

5) Press 2 Time Between Log.

Enter hours, minutes, seconds.

6) Press 3 for Number of Inputs.

Enter the number of inputs to be monitored.

7) Press 4 for Line length.

Enter number of characters you want per line in your printout.

2-Activity Log:

1) Return to the Data Log menu.

Press 2 for Activity Log.

2) Press 1 to disable.

Press 2 to enable.

SYSTEM [0]

The following parameters determine the functioning of various system features.

1. Password - The password is a security feature that you may program to prevent unauthorized access to Express II's programming. The password may be any combination of up to 6 digits.

2. Date and Time - Setting the current date and precise time is critical for operation of various features of the Express II. For example, to make proper use of the alarm calling schedule and any data logging, the unit Clock must be set.

3. Acknowledgment Code - (default: 555) The acknowledgment code is the number, up to 6 digits, you enter when you acknowledge an alarm using a Touch-Tone phone. This code is also used when you call Express II back using a Touch-Tone phone to acknowledge an alarm. **NOTE:** This code cannot be used from a pulse (rotary) phone.

4. Halt Mode Delay time - Halt mode allows you to disable all inputs and prevent dial out for a user-programmed time. Halt mode is useful if you must perform periodic tests or other activities that would trip false alarms and initiate dial out. Halt mode can be programmed from 0 seconds to 12 hours.

NOTE: If you program the halt mode time to zero, the halt mode feature is disabled. The default is 1 hour.

5. Callback Acknowledgment - This feature determines whether you can simply call Express II back to acknowledge an alarm or if you must also enter the acknowledgment code. When callback acknowledgment is enabled, you may acknowledge an alarm from either a pulse or Touch-Tone phone. No code needs to be entered. After receiving the alarm call, you just call the unit back. When callback acknowledgment is disabled, you must use a Touch-Tone phone to acknowledge the alarm by entering the acknowledgment code, or else acknowledge the alarm locally.

Note that with Callback enabled, the unit will not answer until the phone has rung **10** times, regardless of what number of rings the alarm feature is set to. (See also "Unit Configuration" below.)

6. Call Cancel - This feature determines whether or not Express II will continue dialing out for an alarm after the alarm has physically cleared.

SYSTEM PARAMETERS

- 1) Press Program.



- 2) Press System.



- 3) System menu will be displayed.

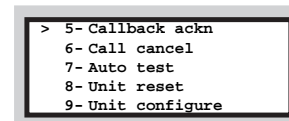
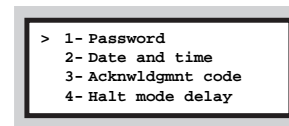

1-Password:

- 1) Press 1 to program password.
- 2) Enter password.(up to 6 digits)
The default is no password.

2-Date and time:

- 1) Press 2 to set Clock.
- 2) Enter: day, month, year, hours, minutes, seconds, and day of the week.

3-Acknowledgment code:

- 1) Press 3 for Acknowledgment Code.
- 2) Enter code. (6 digits; the default is '555')

4-Halt mode delay time:

- 1) Press 4 for Halt Mode Delay Time.
- 2) Enter minutes.

When Call Cancel is enabled, Express II will stop dialing out when the alarm clears, even if the alarm has not yet been acknowledged. When Call Cancel is disabled, Express II will continue dialing out for the alarm until it receives acknowledgment, even if the alarm clears in the meantime.

7. Auto Test - This feature allows you to simulate an alarm on an input to test the dial out procedure. When you call Auto Test, it will ask you to specify an input number to test. NOTE: Auto test will make actual phone calls to the Phone Contacts using the specifications you programmed. You must acknowledge the alarm as if it were real.

Also, the Auto Test feature will not work if "Call Cancel" is enabled (see #6 above).

8. Unit reset- Generally for factory use, the Unit Reset feature will reset the various unit parameters you've programmed in. Should you want to reset the unit, enter a reset code of "159," and press Enter. Choose from Full Reset, Programming Reset, or Voice Reset.

Note: only "Voice reset" offers options. Selecting the other two will clear system parameters.

9. Unit configuration- The Unit Configuration menu offers you three choices:

1 - **RS232 Rate** (default: 9600 baud): This is the baud rate for the RS232 port to which you would connect a printer. Its default setting is 9600 baud. You can reset it in a range from 1200 to 38,400.

2 - **Callback Rings** (default: 10): As mentioned under the "Callback Acknowledgment" section above, the Express II will not answer your call to acknowledge an alarm until the phone has rung ten times. This is the default setting. If you wish, you can change that number here.

3 - **Ack over voice (default: disabled)**: This feature, when activated, allows you to punch in a code number of "555" while the unit is speaking to cut off the message. This is a factory testing feature and in practice is not a dependable override. Generally it should be left disabled. (See Chapter 5: System, Acknowledgement Code for more information on setting the code number.)

5. Callback acknowledgment:

- 1) Press 5 for Callback Acknowledge.
- 2) Enter 1 to enable.
Enter 0 to disable.

6. Call Cancel:

- 1) Press 6 for Call Cancel enabling.

7. Auto Test:

- 1) Press 7 for Auto Test.
- 2) Enter input number.
- 3) Press Enter.

Note that Call Cancel and Auto Test are mutually exclusive.

8. Unit Reset:

- 1) Press 8 for Unit Reset
- 2) Full reset: "Enter" clears everything.

Programming reset: clears programming settings you've entered and returns them to the defaults.

Voice messages reset: resets individual expansion card messages and/or the voice ID message.

9. Unit Configure

- 1) Press 9 for Unit configuration.
Choose from:

RS232 rate: Set this rate from 300-38,400 bauds

Callback rings to answer: choose a new number if you don't want 10.

Ack over voice: choose from disabled/enabled.

SECURITY

Express II allows you to lock the keyboard using the system password to prevent unauthorized personnel from making programming changes using the keypad or via Touch-Tone phone. Inquiry, status and alarm reports may be obtained without the password.

The keyboard may only be locked locally using the keypad. You cannot lock the keypad remotely via Touch-Tone phone.

When programming locally, you must unlock the keypad if it is locked, and relock when finished.

When programming remotely via Touch-Tone phone, you must enter the password to access the programming. The keypad remains locked locally.

SECURITY PARAMETERS

To Lock:

- 1) Press Program.
- 2) Press Lock/Unlock key.



- 3) Enter System password.
- 4) Express II will indicate: "Locked" or "Unlocked" in a voiced response.

To Unlock:

REPEAT LOCK INSTRUCTIONS

NOTE:

Programming is allowed only when the keyboard is Unlocked. System Inquiry will not include password.



NOTES

I. Express II Detects a Change at the Sensor	Variable Factors	Indicator Light
<ul style="list-style-type: none"> Express II detects a change in the monitored condition (from the sensor wired to one of the inputs). This is considered an <i>alert condition</i>, and does not qualify as a valid alarm at this point. The condition continues throughout the programmed Recognition Time. If the condition (or sensor) reverts to its normal state before the Recognition Time is reached, no alarm will occur. 	<p><i>Input Type and Configuration</i></p> <p><i>Recognition Time: Activated</i></p>	<p><i>Changes from steady green to blinking green</i></p>
II. A Valid Alarm Is Recognized	Variable Factors	Indicator Light
<ul style="list-style-type: none"> The condition must persist long enough to meet or exceed the programmed Recognition Time. When Recognition Time has expired, (or if set to zero), and the alarm condition continues, the Express II will determine that a valid alarm exists. When a valid alarm is determined, Call Delay is activated (if not set to zero), forcing the Express II to wait for a programmed period of time before starting the dial-out process. Call Delay applies to the period just prior to dial-out, before the first telephone call is made. Call Delay provides the opportunity to cancel a valid alarm at the Express II's installation site, before dial-out occurs. An audible voice message indicates which of the inputs is in alarm. If on-site personnel acknowledge the alarm within the Call Delay time, the Express II will not dial out. (Local Voice Mute is disabled, so that alarm messages can be heard at the site.) 	<p><i>Recognition Time: Expired</i></p> <p><i>Valid Alarm: Exists</i></p> <p><i>Call Delay: Activated</i></p> <p><i>Alarm Message: Audible, On-site Activated</i></p> <p><i>Local Voice Mute: Disabled</i></p>	<p><i>Changes from blinking green to blinking red.</i></p>



III. Dial-out Begins	Variable Factors	Indicator Light
<ul style="list-style-type: none">• The dial-out process is activated as soon as the Call Delay time expires (if the alarm has not been cancelled at the Express II's installation site.) The dial-out begins with the first selected telephone number, and proceeds sequentially, through the remaining telephone numbers listed in the dialout selection.• Call Progress, an automatic feature, enables the Express II to detect whether or not the telephone call is answered. After 10 rings, or if a busy signal is encountered, the Express II will hang up, wait the programmed Intercall Time, and proceed to dial the next telephone number.• When the telephone is answered, the Express II will immediately begin reciting a message that indicates which of the inputs is in alarm. The Express II will request acknowledgement, if it has not yet occurred.• When the telephone is answered, the programmed Voice Repititions determine the number of times per call the Express II recites the alarm message.• If the alarm is not acknowledged with the first dial-out telephone call, the Express II waits the duration of Intercall Time before dialing the next telephone number. Intercall Time is the programmed waiting period in between each dial-out telephone call.• If no telephone calls are answered, the Express II dials out sequentially, through the remaining telephone numbers and continues to cycle until the programmed Maximum Number of Calls is reached.	<p><i>Call Delay: Expired</i></p> <p><i>Call Progress: Activated</i></p> <p><i>Alarm Messages: By Telephone</i></p> <p><i>Voice Repititions: Activated</i></p> <p><i>Intercall Time: Activated</i></p> <p><i>Max Calls: Activated</i></p>	<p><i>Red light continues blinking</i></p> <p><i>Red light continues blinking</i></p>

IV. The Alarm is Acknowledged	Variable Factors	Indicator Light
<ul style="list-style-type: none"> At any time after a valid alarm is determined, the alarm may be acknowledged at the Express II's installation site, by pressing ALARM CANCEL. When the Express II dials out and the call is answered using a Touch-Tone telephone, it may be instantly acknowledged by pressing "555" (the default code) or by entering a programmable code. The alarm message repeats for the number of programmed Voice Repetitions. If "555" has been entered, the Express II will say: "OK." The alarm is considered acknowledged and the dialout will stop. (If the alert condition continues to exist, then Reset Time may reactivate the dial out process—refer to Reset Time, page 32-33.) If the Express II does not receive the Touch-Tone code, it recites the following: "No Acknowledgment." After the acknowledgment period, it says: "Press any key for unit activity." If a key is pressed, the unit enters command mode. If no key is pressed it will hang up. The recipient of this message must call the Express II back within the period programmed for Intercall Time, in order to acknowledge the alarm. If local voice mute is off, the unit will beep at the installation site while waiting for this call. 	<p><i>Local, On-site Acknowledgment</i></p> <p><i>Touch-Tone Acknowledgment: Fast Code 555</i></p> <p><i>Touch-Tone Acknowledgment: Default Code 555</i></p> <p><i>Tone or Pulse Callback Acknowledgment: Within Intercall Time</i></p>	<p><i>Red light blinks until alarm is acknowledged</i></p>



IV. The Alarm is Acknowledged	Variable Factors	Indicator Light
<ul style="list-style-type: none">• Callback: The Express II waits 10 rings before answering to guard against random acknowledgment. If an answering device is connected to the same line as the Express II and TAD is enabled, the Express II will answer on the first ring. Once answered, the Express II will recite a status report and say: <i>“Have a good day.”</i> <p>When the Express II hangs up, the alarm is acknowledged and dial-out stops (unless Alert Conditions still exist—see Reset Time, below).</p> <ul style="list-style-type: none">• If calls remain unanswered, or if they are received by an answering machine or FAX, the Express II continues the dialout sequence; it waits the Intercall Time and proceeds to dial the next telephone number. Telephone numbers are dialed sequentially, and this cycle continues for the number of Max Calls programmed. If no acknowledgment occurs, then at the completion of Max Calls, the alarm is automatically acknowledged and the dial-out process stops (unless Alert Conditions still exist—see Reset Time, below).• If an alarm is acknowledged by telephone or at the local keypad, yet the alert condition continues to exist, the Express II will reactivate the dialout process, following a programmable waiting period, or Reset Time. If Reset Time is set to zero, the dialout process will not be repeated for that alarm.	<p><i>Tone or Pulse Callback Acknowledgment: TAD Enabled</i></p> <p><i>Max Calls Acknowledgment</i></p> <p><i>Reset Time</i></p>	<p><i>Red light blinks until alarm is acknowledged</i></p> <p><i>Changes from blinking red to steady red if acknowledged and alert condition still exists.</i></p> <p><i>Changes from steady red back to blinking red when Reset Time reactivates dialout.</i></p> <p><i>Changes from blinking red to steady green when alarm is acknowledged and alert condition no longer exists.</i></p>



NOTES

CHAPTER 7: OTHER KEYPAD FUNCTIONS

INQUIRING:

The same menu system that is used for programming the Express II is also used to verify programming. To check the programming of a particular parameter, just follow the same steps as if programming, except start with the INQUIRE key *instead of* the PROGRAM key. The Express II will prompt you with the same menu choices as if you were programming until you have reached the desired information. Express II will 'speak' the programming parameters and display them at the same time. You can also:

Inquire Status:

General status information can also be requested from the keypad. If you press INQUIRE and then STATUS, the Express II will first give you information from internal functions on power, battery and sound levels, then ask what else you want status information from. You will be given four choices:

- 1-Input Status
- 2-Output Status
- 3-Mic Listen In (valid only remotely)
- 4-Dump Programming

1-2 - Input/Output Status: If you choose Input or Output Status the Express II will ask you for an input or output number or have you press "99" to hear the status of all inputs or outputs.

3 - Mic Listen In: Allows you to listen in to sounds on site through the Express II's microphone.

4 - Dump Programming: Dumps all the program settings to a printer for recording. Remember that you must have a printer with a serial port connected to the Express II in order to use this feature. It is useful if you wish to clear and reprogram the unit or to have a printed record of settings.

Inquiring

- 1) Press Inquire.



- 2) Press Status



- 3) The Express II will read off current power and sound settings, and then display a menu of choices:

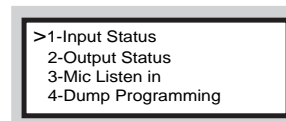

- 4) If you select **Input status** or **Output status**, the Express II will ask you to select a specific input/output, or else choose all of them by pressing "99."

- 5) **Mic Listen In** is useful if you need to hear on-site sounds, and activates the Express II microphone.

Inquire Alarms:

To check alarm information, press INQUIRE and then ALARMS. If there are any unacknowledged alarms, the Express II will recite which input alarms have not been acknowledged. Otherwise it will tell you that no alarms are active.

Halt Mode Delay Time

Halt mode allows you to disable all inputs and prevent dial out for a user-programmed time. Halt mode is useful if you must perform periodic tests or other activities that would trip false alarms and initiate dial out. The Input lights will flash red for the duration. Halt mode can be programmed from 0 seconds to 12 hours.

To initiate Halt mode press the orange HALT button. To exit Halt mode press ALARM CANCEL.

NOTE: If you program the halt mode time to zero, the halt mode feature is disabled. The default setting is 1 hour. (See also "Halt mode delay time" as part of the System programming section of Chapter Five.)

6) **Dump Programming** is useful only when a printer with a serial port is connected to the Express II. It does not reset or clear settings. For that, consult "System" in Chapter 5.

Inquire Alarms:

- 1) Press Inquire



- 2) Press Alarms



.....

CHAPTER 8: REACHING EXPRESS II BY TELEPHONE

Express II is at your disposal whenever you need it - no matter where you are. And it's as easy as dialing your telephone! All you need is your Express II's phone number and a Touch-Tone phone.

Simply follow these first steps to reach Express II's built-in, voice-guided system. The voice-guided system comprises a main menu and proceeding sub-menus. It works much the same as when you are programming Express II. The only difference is that you use the telephone dial pad in place of the Express II keypad.

Phone-in Parameters:

Dial the phone number of your Express II unit.

Express II will pick-up and 'say':

"Hello, this is... (*programmed ID message that you record*)"

Enter Password (*if you programmed one*)

"Press 1 for Status."

" 2 for Alarm."

" 3 to Inquire Programming."

" 4 to Change Programming."

" 5 to Exit."

The Main Menu:

"Press 1 for Status."

The response for this function is the same as the response to [Inquire] [Status] at the local keypad. (See Chapter 7)

"2 for Alarm."

The response for this function is the same as the response for [Inquire] [Alarm] at the local keypad. (See Chapter 7)

"3 to Inquire Programming."

Press 3 for a list of the 10 programming categories (See the primary menu categories in Chapter 5). Once a category is chosen, the menus and responses are identical to those if you were inquiring a programming parameter status at the local keypad.

"4 to Change Programming."

Press 4 for a list of the 10 programming categories. (See the primary menu categories in Chapter 5) Once a category is chosen, the menus and responses are identical to programming at the local keypad.

"5 to Exit."

Press 5 and the unit will respond, "Have a good day!" The unit will then hang up.



Special Keys:

Press the "star" button(*) once to repeat the current menu.
Press the "star" button(**) twice to repeat the previous menu.
Use the "pound" button(#) as the Enter key.

Notes regarding uses of the "Star" Button[*]: During the programming of Phone Contact Numbers, the "Star" [*] button is the Code Key--i.e., for Code 1 you would press "**1". If, on the other hand, you are inputting analog tables or alarm limits, if you press the "star" button [*] **before** a digit, it acts as a minus [-] sign; if you press the "star" button[*] **after** a digit, it acts as a decimal point.

Security:

The unit's local keypad may not be "Unlocked" or "Locked" over the phone. This will not affect any Phone-in parameters; however, if the local keypad is "Locked" you must know the System Password to gain access and change programming over the telephone. Press the pound sign (#) after the password.

Note: The ID message must be recorded after installation. There is no default ID message. However, it *can* be recorded over the phone. Just remember that message time limits apply. (See "Messages" section of Chapter 5.)
Input Calibration cannot be programmed over the phone

PHONE CONTACT LIST

	NAME	PHONE NUMBER	SCHEDULE*		
			ALL/DAY	NIGHT	WEEKEND
1.	_____	_____	<input type="checkbox"/>	<input type="checkbox"/>	<input type="checkbox"/>
2.	_____	_____	<input type="checkbox"/>	<input type="checkbox"/>	<input type="checkbox"/>
3.	_____	_____	<input type="checkbox"/>	<input type="checkbox"/>	<input type="checkbox"/>
4.	_____	_____	<input type="checkbox"/>	<input type="checkbox"/>	<input type="checkbox"/>
5.	_____	_____	<input type="checkbox"/>	<input type="checkbox"/>	<input type="checkbox"/>
6.	_____	_____	<input type="checkbox"/>	<input type="checkbox"/>	<input type="checkbox"/>
7.	_____	_____	<input type="checkbox"/>	<input type="checkbox"/>	<input type="checkbox"/>
8.	_____	_____	<input type="checkbox"/>	<input type="checkbox"/>	<input type="checkbox"/>
9.	_____	_____	<input type="checkbox"/>	<input type="checkbox"/>	<input type="checkbox"/>
10.	_____	_____	<input type="checkbox"/>	<input type="checkbox"/>	<input type="checkbox"/>
11.	_____	_____	<input type="checkbox"/>	<input type="checkbox"/>	<input type="checkbox"/>
12.	_____	_____	<input type="checkbox"/>	<input type="checkbox"/>	<input type="checkbox"/>
13.	_____	_____	<input type="checkbox"/>	<input type="checkbox"/>	<input type="checkbox"/>
14.	_____	_____	<input type="checkbox"/>	<input type="checkbox"/>	<input type="checkbox"/>
15.	_____	_____	<input type="checkbox"/>	<input type="checkbox"/>	<input type="checkbox"/>
16.	_____	_____	<input type="checkbox"/>	<input type="checkbox"/>	<input type="checkbox"/>
17.	_____	_____	<input type="checkbox"/>	<input type="checkbox"/>	<input type="checkbox"/>
18.	_____	_____	<input type="checkbox"/>	<input type="checkbox"/>	<input type="checkbox"/>
19.	_____	_____	<input type="checkbox"/>	<input type="checkbox"/>	<input type="checkbox"/>
20.	_____	_____	<input type="checkbox"/>	<input type="checkbox"/>	<input type="checkbox"/>
21.	_____	_____	<input type="checkbox"/>	<input type="checkbox"/>	<input type="checkbox"/>
22.	_____	_____	<input type="checkbox"/>	<input type="checkbox"/>	<input type="checkbox"/>
23.	_____	_____	<input type="checkbox"/>	<input type="checkbox"/>	<input type="checkbox"/>
24.	_____	_____	<input type="checkbox"/>	<input type="checkbox"/>	<input type="checkbox"/>

*Schedule Options:

Schedule 1: ALL. Schedule 2: 1-24=DAY, 25-48=NIGHT.

Schedule 3: 1-16=DAY. 17-32=NIGHT. 33-48=WEEKENDS

for further information see "Phone Parameters" in Chapter 5.

PHONE CONTACT LIST

	NAME	PHONE NUMBER	SCHEDULE*		
			All/Day	Night	Weekend
25.			<input type="checkbox"/>	<input type="checkbox"/>	<input type="checkbox"/>
26.			<input type="checkbox"/>	<input type="checkbox"/>	<input type="checkbox"/>
27.			<input type="checkbox"/>	<input type="checkbox"/>	<input type="checkbox"/>
28.			<input type="checkbox"/>	<input type="checkbox"/>	<input type="checkbox"/>
29.			<input type="checkbox"/>	<input type="checkbox"/>	<input type="checkbox"/>
30.			<input type="checkbox"/>	<input type="checkbox"/>	<input type="checkbox"/>
31.			<input type="checkbox"/>	<input type="checkbox"/>	<input type="checkbox"/>
32.			<input type="checkbox"/>	<input type="checkbox"/>	<input type="checkbox"/>
33.			<input type="checkbox"/>	<input type="checkbox"/>	<input type="checkbox"/>
34.			<input type="checkbox"/>	<input type="checkbox"/>	<input type="checkbox"/>
35.			<input type="checkbox"/>	<input type="checkbox"/>	<input type="checkbox"/>
36.			<input type="checkbox"/>	<input type="checkbox"/>	<input type="checkbox"/>
37.			<input type="checkbox"/>	<input type="checkbox"/>	<input type="checkbox"/>
38.			<input type="checkbox"/>	<input type="checkbox"/>	<input type="checkbox"/>
39.			<input type="checkbox"/>	<input type="checkbox"/>	<input type="checkbox"/>
40.			<input type="checkbox"/>	<input type="checkbox"/>	<input type="checkbox"/>
41.			<input type="checkbox"/>	<input type="checkbox"/>	<input type="checkbox"/>
42.			<input type="checkbox"/>	<input type="checkbox"/>	<input type="checkbox"/>
43.			<input type="checkbox"/>	<input type="checkbox"/>	<input type="checkbox"/>
44.			<input type="checkbox"/>	<input type="checkbox"/>	<input type="checkbox"/>
45.			<input type="checkbox"/>	<input type="checkbox"/>	<input type="checkbox"/>
46.			<input type="checkbox"/>	<input type="checkbox"/>	<input type="checkbox"/>
47.			<input type="checkbox"/>	<input type="checkbox"/>	<input type="checkbox"/>
48.			<input type="checkbox"/>	<input type="checkbox"/>	<input type="checkbox"/>

*Schedule Options:

Schedule 1: ALL. Schedule 2: 1-24=DAY, 25-48=NIGHT.

Schedule 3: 1-16=DAY. 17-32=NIGHT. 33-48=WEEKENDS

for further information see "Phone Parameters" in Chapter 5.



PROGRAMMING SUMMARY

I. PHONE

- A. Calling Schedule
 - 1. all
 - 2. days and nights
 - a. enter day hours; enter day minutes
 - b. enter night hours; enter night minutes
 - 3. day, night, and weekends
 - a. enter day hours; enter day minutes
 - b. enter night hours; enter night minutes
- B. Phone Contacts
 - 1. enter position number / "phone number selection"(1-48)
 - a. voice
 - b. beeper
 - 2. enter phone number
- C. To Remove a Phone Contact Number
 - 1. phone
 - 2. phone contacts
 - 3. specific assigned contact number
 - 4. enter

.....

II. DIAL OUT

- A. Dialing method**
 - 1. pulse
 - 2. tone
 - 3. automatic
- B. Retries on Busy**
 - 1. enter number of retries on busy
- C. Message Repeats**
 - 1. enter number of times alarm message will repeat for each call
- D. Maximum Number of Calls**
 - 1. enter total number of outgoing calls during an alarm
- E. Call Delay Time**
 - 1. enter hours
 - 2. enter minutes
 - 3. enter seconds
- F. Intercall Delay Time**
 - 1. enter hours
 - 2. enter minutes
 - 3. enter seconds



III. DIAL IN

A. Rings Until Answer

1. enter number of rings until Express II answers
(see section on TAD in Chapter Five)

B. Telephone Answering Device (TAD)

1. enable
2. disable

.....

IV. MESSAGES

- A. Record ID Message**
 - 1. speak message
- B. Record Input Message**
 - 1. enter input number
 - 2. speak message
- C. Record Output Message**
 - 1. enter output number
 - 2. speak message
- D. Message Length**
 - 1. enter 5
 - 2. enter 7
 - 3. enter 11



V. INPUTS

- A. Enter Input Number (1-40)
 - 1. enable/disable
 - 2. input type
 - a. normally closed
 - b. normally open
 - c. pulse count
 - d. 4-20 milliamp
 - 1. enter table low limit
 - 2. enter table high limit
 - e. 0-5 volt
 - 1. enter table low limit
 - 2. enter table high limit
 - f. temperature
 - 1. 2.8K °F thermistor
 - 2. 2.8K °C thermistor
 - 3. 10K °F thermistor
 - 4. 10K °C thermistor
 - g. time accumulator
 - 3. recognition time
 - a. enter hours
 - b. enter minutes
 - c. enter seconds
 - 4. high/low limits
 - a. enter low limit
 - b. enter high limit
 - 5. alarm reset time
 - a. enter hours
 - b. enter minutes
 - c. enter seconds
 - 6. dial out selection
 - a. establish specific number for each input
 - b. enter position numbers (1-48)
 - 1. press enter twice

.....

VI. SOUND

- A. Listen-in Time**
 - 1. enter seconds (0-255)
- B. Sound Monitoring**
 - 1. disable
 - 2. enable
- C. Sound Sensitivity**
 - 1. enter value (0-100)
- D. Recognition Time**
 - 1. enter hours
 - 2. enter minutes
 - 3. enter seconds
- E. Alarm Reset Time**
 - 1. enter hours
 - 2. enter minutes
 - 3. enter seconds
- F. Dial Out Selection**
 - 1. enter position numbers (1-48)
- G. Mute Local Speaker**
 - 1. disable
 - 2. enable



VII. AC POWER

A. AC Power

- 1. failure monitor**
 - a. disable**
 - b. enable**
- 2. power recognition time**
 - a. enter hours**
 - b. enter minutes**
 - c. enter seconds**
- 3. alarm reset time**
 - a. enter hours**
 - b. enter minutes**
 - c. enter seconds**
- 4. dial out selection**
 - a. enter position numbers (1-48)**

B. Battery

- 1. battery monitor**
 - a. disable**
 - b. enable**
- 2. alarm reset time**
 - a. enter hours**
 - b. enter minutes**
 - c. enter seconds**
- 3. dial out selection**
 - a. enter position numbers (1-48)**

VIII. OUTPUTS

A. Enter Output Number

- 1. on-board output (output 0)**
 - a. manual**
 - b. automatic**
- 2. optional outputs--manual**
 - a. off**
 - b. on**



IX. DATA LOG

A. Input Log

- 1. enable/disable**
- 2. time between logs**
 - a. enter hours**
 - b. enter minutes**
 - c. enter seconds**
- 3. number of inputs**
- 4. line length**

B. Activity Logs

- 1. enable**
- 2. disable**

.....

X. SYSTEM

- A. Password**
 - 1. enter password (up to 6 digits)
- B. Date and Time**
 - 1. enter month
 - 2. enter day
 - 3. enter year
 - 4. enter hours
 - 5. enter minutes
 - 6. enter seconds
- C. Acknowledgment Code**
 - 1. enter code (3 digits; default=555)
- D. Halt Mode Delay Time**
 - 1. enter hours
 - 2. enter minutes
 - 3. enter seconds
- E. Callback Acknowledgment**
 - 1. disable
 - 2. enable
- F. Call Cancel**
 - 1. disable
 - 2. enable
- G. Auto Test (only if call cancel is disabled)**
 - 1. enter input number
- H. Unit Reset**
 - 1. enter code 159
 - a. full reset
 - b. programming reset
 - c. voice reset
 - 1. expansion cards
 - 2. ID message
- I. Unit Calibration**
 - 1. RS232 rate (default 9600 baud)
 - a. baud rates 300–38,400
 - 2. callback rings (default 10)
 - 3. ack over voice
 - a. disabled
 - b. enabled



XI. SECURITY

A. Lock

- 1. program**
- 2. lock/unlock key**
- 3. enter system password**

B. Unlock

- 1. program**
- 2. lock/unlock key**
- 3. enter system password**



NOTES



APPENDIX A: TROUBLESHOOTING

In the event that a problem is encountered, this section will assist you in determining the cause, so that you can return the unit to its monitoring routine with minimal interruption.

Most problems with the Express II are easy to identify and can be quickly corrected, and are found under the following general headings:

- Communications/Dial-Out
- Temperature Monitoring
- Sound Level Monitoring
- Other Monitoring Functions

If you have tried the solutions outlined in this section and are not satisfied with the results, call Phonetics Technical Support at (610)558-2700, or follow the guidelines for shipping the Express II to Phonetics for service (see Appendix D).

Problem	Cause	Solution
<p>I. COMMUNICATIONS/ DIALOUT</p> <p>1. The Express II won't dial out for an alarm</p>		<p>An unacknowledged alarm exists when the LED for the input is blinking red. The unit will not dial out unless there is a red blinking LED. A blinking green LED indicates that the input has an alarm but has not met the recognition time yet. An unacknowledged alarm does not exist until the recognition time has been met. A steady red LED indicates that the alarm is acknowledged and no dialout will occur. Check the following items: Make sure the input is enabled; check the recognition time for the input; make sure a phone number is programmed; make sure the input has contact numbers selected for the dialout; make sure the phone number to be called is within the calling schedule time period.</p> <p>Set the call delay time shorter.</p>

Problem	Cause	Solution
<p>2. The Express II will not answer the telephone when called for a status report.</p> <p>3. The Express II will not answer the telephone when called back for alarm acknowledgment.</p> <p>4. The Express II dials out correctly but fails to audibly recite its alarm message when you answer the call.</p>		<p>Check the telephone number programming. Does your telephone system require a "9" to connect with an outside line?</p> <p>If you are on an older phone system, try setting the dialing method to "pulse." If this doesn't work, try setting it to "tone." (See also "Dial Out Parameters" in Chapter Five.)</p> <p>Increase maximum number of calls to a number greater than or equal to one. (See Dial Out Parameters)</p> <p>The Express II must be connected to a standard (2-wire analog) telephone line, and NOT a digital extension to a phone system. If the unit will not dial out and the factors previously listed have been ruled out, try connecting the unit to a standard residential telephone line and see if it will operate on that line.</p> <p>Recheck the programming of "rings until answer" feature. (See "Dial In Parameters" in Chapter Five.)</p> <p>Allow the telephone to ring ten times.</p> <p>Reprogram voice repetitions to 1 or greater.</p>



5. The Express II and telephone answering device (sharing the same line) answer incoming calls simultaneously.

The Express II's number of "rings until answer" is set to the same number of rings as the telephone answering device.

Increase the "rings until answer" in the Express II.

II. TEMPERATURE MONITORING

1. The temperature reading is low: -85°F or -65°C.

Open circuit on the input.

Check wires for a loose connection or broken wire.

2. The temperature reading is high: 200°F or 93°C.

The circuit is shorted.

Check the wiring to see if the wires touch.

3. The temperature reading is inaccurate.

The sensor may be incompatible with the unit. See 2.8K and 10K thermistor look-up tables in Chapter Three.

Replace the sensor with a compatible model.

The sensor may simply need calibration.

Calibrate the input. See "Inputs" in Chapter Five for information on calibrating the input properly.

III. SOUND MONITORING

1. False high sound alarms occur frequently.

The programmed sound sensitivity and recognition time results in over-sensitivity to non-alarm sounds as well as alarm sound.

Reprogram the sound sensitivity to a less sensitive value and increase the recognition time. See "Sound" in Chapter Five.

2. High sound does not cause an alarm.

The microphone is not close enough to the sound source, or the programmed sound setting results in a lack of sensitivity to the high sound.

Move the microphone closer to the sound source and/or reprogram the sensitivity and recognition time. See "Sound" in Chapter Five.

Problem	Cause	Solution
<p>IV. OTHER</p> <p>1. Alarm status of input is incorrect.</p> <p>2. The unit won't perform an autotest.</p> <p>3. The unit calls again with the same alarm after I acknowledge it.</p>	<p>Incorrect input normality.</p> <p>The call-cancel feature is enabled. An auto test won't execute if this feature is enabled.</p> <p>Alarm reset time is set at too short an interval.</p> <p>Alarm condition is sporadic, going on and off.</p>	<p>Reprogram the input type to the correct normality. See "Inputs" in Chapter Five.</p> <p>Disable the Call Cancel feature. (See Chapter Five)</p> <p>Increase the "Alarm reset" value. See "Alarm Reset Time" sections in Chapter Five and "Alarm is Acknowledged" in Chapter Six.</p> <p>Lengthen recognition time. See various "Recognition Time" sections in Chapter Five.</p>

.....

APPENDIX B: CHECKING YOUR EXPRESS II FOR PROPER OPERATION

We recommend that you test your Sensaphone weekly to be sure it is functioning properly. This will ensure that when a problem arises the Sensaphone will be ready to alert the appropriate personnel.

There are several tests that can be performed:

- 1) Call the unit and listen to a Status Report. This will test the unit's ability to answer the phone and speak a message. It will also verify that all of the inputs are reading properly, the alarm conditions are OK, the power is on and the microphone is functioning.
- 2) Create an alarm on each input and allow the unit to contact all programmed telephone numbers. This will ensure that the Sensaphone is programmed properly. It will also prepare personnel to respond appropriately when they receive a call from the Sensaphone.
- 3) Test the battery by unplugging the AC adapter and making sure that the Sensaphone continues to function. Press INQUIRE, then STATUS on the keypad, and listen to the status report. Make sure the report states that "the power is off" and "the battery level is 13.5 volts" (or higher). Keep the AC adapter unplugged so that a Power Failure alarm occurs. Allow the unit to dial all programmed telephone numbers while running on battery backup. Plug in the AC adapter after the unit has finished dialing all of the telephone numbers.
- 4) If you are using your Sensaphone to listen for a smoke alarm, then be sure to test the smoke alarm to make sure that the Sensaphone picks up the audible signal and triggers a high-sound-level alarm. Allow the unit to dial all programmed telephone numbers.



APPENDIX D: ENGINEERING SPECIFICATIONS

I. General

The Automatic dialer shall be a self-contained microprocessor controlled system capable of monitoring and controlling up to 40 alarm channels. The system shall be modular in construction, allowing up to 4 input/output Expansion Cards to be installed and configured for operation by the user by means of the built-in keypad and remotely by touch-tone phone. Characteristics of Input and Output channels include Universal Input and Digital Relay Output.

Upon detection of any alarm or status change, the system shall commence dialing telephone numbers from a list associated with the particular alarm condition(s) or combination thereof, and deliver a voice message identifying and describing the alarm condition(s). The alarm message shall be delivered in digitized human voice using messages recorded by the user. The system will continue to call telephone numbers in succession until a positive acknowledgment of the alarm message is received. Acknowledgment is accomplished by depressing tone keys from the called telephone, or by calling the system back within a programmed time period. The alarm may also be acknowledged using the local keypad. In addition, the system shall be able to receive incoming telephone calls. Upon answering, the system shall recite a status report and allow access to remote operation and programming.

The system shall be FCC registered for direct connection to the telephone network. The system shall have a one year warranty from the manufacturer. The system shall be a Sensaphone® Express II by Phonetics, Inc.

II. I/O Channel Attributes and Features

A. Inputs

The system shall come standard with 8 universal input channels. Up to 32 additional universal input channels may be installed by the user. All input channels shall be user-configurable as:

1. NO or NC digital dry contact, using 0.8mA loop current
2. 4-20mA analog, using custom look up table
3. 0-5V analog, using custom look up table
4. Pulse count
5. Temperature from thermistor, using 2.8K or 10K devices
6. Time accumulator

The system shall have the following built-in monitoring features:

1. AC power failure detection
2. Sound level monitoring
3. Low battery detection

.....

All monitored channels, including built-in monitoring features, shall allow keyboard and remote touch-tone programming of pertinent operational data including, but not limited to:

1. Input type (NO/NC, 4-20mA and 0-5V analog, pulse count, thermistor, time accumulator)
2. High and Low limits (-9999 to +9999)
3. Input recognition time (0 seconds to 12 hours)
4. Alarm reset time (0 seconds to 12 hours)
5. Phone Contacts list for each channel
6. Enable/disable for each channel to dialout for alarm

B. Outputs

The system shall have one built-in SPST latching 2A 250VAC relay output. The output may be programmed to switch automatically on alarm or manually via keyboard or Touch-Tone™ phone. Up to 16 additional relay output channels may be installed by the user.

III. Communications Features

A. Telephone Specifications

The system shall connect to a standard 2-wire telephone line using pulse or tone dialing methods, with loop start only. The system shall recognize ringer frequencies from 16 to 60 Hz. No leased or dedicated lines shall be required. The system shall also be capable of being used on the same telephone line as other answering devices. Call progress detection shall ensure that the alarm dialout is not hindered by no-answers or busy signals.

B. Telephone Numbers

The system shall be capable of dialing up to 48 telephone numbers, 40 digits each. There shall be a capacity to program, retain and use three separate lists based on a calling schedule of weekday, weeknight and weekend. Each list shall contain up to 16 phone numbers. In addition, individual phone contact lists may be programmed for each input channel.

The system shall allow local keypad and remote touch-tone programming of the following telephone dialing information:

1. Dialing method (Automatic, pulse, tone)
2. Retries on busy (0 to 15)
3. Message repetitions (0 to 10)
4. Maximum number of calls (0 to 65,535)
5. Call delay time (0 seconds to 12 hours)
6. Intercall delay time (0 seconds to 12 hours)



C. Voice Messages

The System shall have the ability to record, store and reproduce voice messages and to use those messages to articulate the location and status of the monitored channels. In absence of user-recorded voice messages, the system shall articulate channel status using the internally resident vocabulary. All digitized speech message data shall be stored in nonvolatile memory with a 3V lithium battery backup. Such battery backup shall be capable of protecting speech memory for at least 2 years of complete power outage.

There shall be one recorded identification message for the system, and one recorded alarm message for each input channel. A message may also be recorded for each output channel on the optional output expansion card. Message length shall be selectable from 5 to 11 seconds per input or output channel.

IV. Programming

A. Local Programming

The System shall contain an integral, sealed, alphanumeric keypad for the purpose of locally programming all system data. Programming is assisted by synthesized voice guidance. All operational data, system setup and configuration data, and all information regarding the monitored I/O channels shall be displayed on the LCD display panel. No display manipulation shall be required to view and assess the status of I/O points.

B. Remote Programming

The system shall be remotely programmable using a standard touch-tone telephone. All operational data, system setup and configuration data, and information regarding I/O channels shall be accessible and programmable. A user-programmable security password shall protect the system from unauthorized tampering. Remote programming shall be aided by menu-style voice guidance.

V. System Features

A. Power

The system shall be provided with a UL/CSA listed 15VAC grounded power transformer that the user may plug into a 110V AC outlet, $\pm 20\%$, 60HZ. The unit shall provide battery backed 12 volts DC (up to 100mA) and 24 volts DC (up to 350mA) to power 4-20mA current loops or other external devices.

B. Battery Backup

The system shall have a built-in 12V 3 AH sealed lead-acid rechargeable battery. This battery shall support approximately 6-12 hours of continued system operation in

the absence of AC power. (Actual battery backup performance is dependent upon the age of the battery, the ambient temperature, the charge condition, and the number of external devices being powered by the system.)

C. Local Visual Indication

Each input shall have a corresponding LED that will indicate the alarm and acknowledgment status of each input. The system shall also have an LCD display that will list information about the current system status and input/output status.

D. Data Log

The system shall be capable of logging the input values on a user-defined time period via a serial printer. The system shall also log all system and alarm activity including, but not limited to: programming changes, alarms occurring and clearing, acknowledgments, call-ins, and alarm dialouts. The system shall be able to print the log information to a printer hooked up to its built-in RS232 serial port.

E. Halt Mode

The system shall be capable of entering a halt mode upon user command in which all inputs shall be disabled and dialout prevented. Halt mode shall end automatically after a preprogrammed time period.

F. Diagnostics and Testing

System diagnostics shall be performed each time the unit is started. The system shall be capable of performing a simulated alarm dialout for testing. The dialout can be requested locally or remotely.

G. Security

The system shall allow the user to lock the keypad to prevent unauthorized local or remote access unless a security password is entered.

VI. Remote Operation Features

A. Status Report

The system shall allow the user to call into the unit at any time using any standard telephone to obtain a full status report of all monitored channels. The status report shall be articulated using the resident voice-synthesized English vocabulary, in combination with digitized user-recorded voice messages.

B. Acknowledgment

An alarm on any monitored channel may be acknowledged remotely by pressing tones on a touch-tone telephone keypad or by calling the system back within a specified time period. An alarm may also be acknowledged locally using the built-in keypad.



VII. Enclosure and Environmental

A. Enclosure

The system shall be housed in a NEMA-4 fiberglass enclosure with a latched window cover and shall be internally constructed such that modular plug-in expansion cards may be used to facilitate field upgrades, repair, and maintenance.

B. Electrical Protection

Power and telephone connections shall have internal spike and surge protection using metal oxide varistors. All input channels shall have fault protected input circuits.

C. Additional Electrical Surge Protection

Additional Power and Telephone line surge protection shall be available from the manufacturer. When so installed, the system shall be fully warranted against any damage caused by transient surges entering the system through Power or Telephone lines.

D. Environmental

The system shall function over an operating range of 32°F - 120°F at up to 0 - 90% RH, non-condensing. The system may be stored over the temperature range of 0° - 130°F.

E. Maintenance

The system manufacturer shall have in-house service facilities and technical assistance available during normal business hours, Monday - Friday 8AM - 5PM(EST).

F. Safety Approvals

The system shall be approved by a Nationally Recognized Testing Laboratory (NRTL) to UL Standard 1950 "Information Technology Equipment" and CSA Standard 22.2 #950.

Specifications subject to change without notice.
© 1997 Phonetics, Inc.

Phonetics, Inc.

APPENDIX E: RETURNING THE EXPRESS II FOR SERVICE

In the event that the Express II does not function properly, we suggest that you do the following:

- 1) Record your observations regarding the Express II's malfunction.
- 2) Call the Technical Service Department

If the unit must be sent Servicing, please do the following:

- 1) Turn the power switch Off, disconnect all wiring and unplug the unit.
- 2) Carefully pack the unit to avoid damage in transit. Use the original container (if available) or a sturdy shipping box.



